



**Mixed Ligand Copper(I) Complexes of Triphenylphosphine and
Phenylthiourea**

Ruthairat Nimtong

**A Thesis Submitted in Partial Fulfillment of the Requirements for
the Degree of Master of Science in Physical Chemistry**

Prince of Songkla University

2008

ชื่อวิทยานิพนธ์	สารประกอบเชิงซ้อนของคอปเปอร์ (I) ของลิแกนด์ผสมไตรฟีนิลฟอสฟีน และฟีนิลไธโอยูเรีย
ผู้เขียน	นางสาวฤทัยรัตน์ นิ่มทอง
สาขาวิชา	เคมีเชิงฟิสิกส์
ปีการศึกษา	2550

บทคัดย่อ

สังเคราะห์สารประกอบเชิงซ้อนของคอปเปอร์ (I) เฮไลด์ที่มีลิแกนด์ผสมระหว่างไตรฟีนิลฟอสฟีน (PPh₃) และฟีนิลไธโอยูเรีย (ptu) ทำการศึกษาวิเคราะห์โดยการวิเคราะห์ปริมาณธาตุที่เป็นองค์ประกอบ เอกซเรย์ฟลูออเรสเซนซ์สเปกโทรเมตรี นิวเคลียร์แมกเนติกเรโซแนนซ์สเปกโทรสโกปี และอินฟราเรดสเปกโทรสโกปี สารประกอบเชิงซ้อนสามารถสังเคราะห์ได้โดยการเติมลิแกนด์ ptu ลงไปในสารละลาย CuX-PPh₃ (CuX ; X = Cl, Br และ I) ศึกษาโครงสร้างโมเลกุลของ [CuCl(PPh₃)₂(ptu)] (1) [CuBr(PPh₃)₂(ptu)] (2) และ [CuI(PPh₃)₂(ptu)] (3) โดยเทคนิคการเลี้ยวเบนของรังสีเอกซ์บนผลึกเดี่ยว สารประกอบเชิงซ้อน (1) และ (2) มีโครงสร้างที่เหมือนกัน (isomorphous) ตกผลึกอยู่ในระบบไตรคลินิก หมู่ปริภูมิ P1̄ มีสองโมเลกุลต่อหน่วยเซลล์ มีเซลล์พารามิเตอร์ดังนี้ $a = 10.5226(1)$, $b = 11.3035(2)$, $c = 17.1848(2)$ Å, $\alpha = 97.605(1)$, $\beta = 103.508(1)$, $\gamma = 103.605(1)^\circ$ และ $a = 10.6236(4)$, $b = 11.2135(4)$, $c = 17.1481(7)$ Å, $\alpha = 57.957(1)$, $\beta = 102.424(1)$, $\gamma = 102.994(1)^\circ$ สำหรับสารประกอบเชิงซ้อน (1) และ(2) ตามลำดับ สารประกอบเชิงซ้อน (3) อยู่ในระบบไตรคลินิก หมู่ปริภูมิ P1̄ มีสี่โมเลกุลต่อหน่วยเซลล์ มีเซลล์พารามิเตอร์ดังนี้ $a = 10.9505(9)$, $b = 18.7294(15)$, $c = 21.3731(18)$ Å, $\alpha = 67.4220(10)$, $\beta = 77.2150(10)$, $\gamma = 73.2240(10)^\circ$ ซึ่งแต่ละโครงสร้างเป็นแบบทรงสี่หน้าที่บิดเบี้ยว โดยมีคอปเปอร์ (I) เป็นอะตอมกลางที่สร้างพันธะกับฟอสฟอรัสสองอะตอมจากลิแกนด์ PPh₃ สองโมเลกุล ซัลเฟอร์หนึ่งอะตอมจากลิแกนด์ ptu และอะตอมเฮไลด์หนึ่งอะตอม

ACKNOWLEDGEMENTS

I would like to express my deepest and sincere gratitude to my supervisor, Assistant Professor Dr. Chaveng Pakawatchai, for his valuable instructions, excellent suggestions, expert guidance and kindness.

My sincere thank is expressed to Assistant Professor. Yupa Thunyasirikul for her kindly helpful suggestion comments on my research. Special thanks are addressed to Professor Dr.Narongsak Chaichit at Thammasart University and Miss Saowanit Saithong at Prince of Songkla University for X-ray data collections. I also would like to thank Assistant Professor Dr. Orawan Sirichote, Dr. Weena Aemaeg Tapachai and Mr. Jedsada Mokhagul for valuable suggestions.

Appreciately thank to Higher Education Development Project: Center for Innovation in Chemistry : Postgraduate Education and Research Program in Chemistry (PERCH-CIC) and Graduate School for partial financial supports.

I would also like to thank personnel of Department of Chemistry for their kind help and offer the convenience.

Finally, none of this would have been possible without love and encouragement of my family. I am very grateful to M.Sc. , Ph.D. students and friends, for their kind help and assistance during my studies and research activities.

Ruthairat Nimtong

THE RELEVANCE OF THE RESEARCH WORK TO THAILAND

Copper(I) complexes have received considerable attention since they provide suitable models for the representation of several enzymic sites as well as active intermediates in organic synthetic reactions. The aim of this work is to investigate ligand behaviour in connection with different factors such as the complexing properties of the ligands containing N, S and P as donors and the experimental conditions employed in the synthesis reactions. The mixed ligand copper(I) halide complexes containing triphenylphosphine (PPh₃) and *N*-phenylthiourea (ptu) as ligands were prepared and determined crystal structures of these complexes by single crystal X-ray diffraction.

The knowledge of chemical and physical properties, molecular structures including with many interaction (intra- and inter- molecular interactions) such as hydrogen bonding, metal-metal interactions, electrostatic effect, short-contact and π - π interactions might be expected to develop in various application properties; catalysts, superconductors, semiconductors and photocatalytic isomerizations.

CONTENTS

	Page
CONTENTS	vii
LIST OF TABLES	ix
LIST OF ILLUSTRATIONS	xi
LIST OF ABBREVIATIONS AND SYMBOLS	xiv
1. INTRODUCTION	1
1.1 Introduction	1
1.2 Literature reviews	5
1.3 Objectives	22
2. EXPERIMENT	23
2.1 Materials and Instruments	23
2.2 Chemicals	23
2.3 Preparation of complexes	24
2.3.1 Preparation of [CuCl(ptu)(PPh ₃) ₂] complex	24
2.3.2 Preparation of [CuBr(ptu)(PPh ₃) ₂] complex	24
2.3.3 Preparation of [CuI(ptu)(PPh ₃) ₂] complex	24
2.4 Methods for determination structures	25
2.4.1 Melting point measurement	25
2.4.2 Elemental analysis	
2.4.3 X-ray fluorescence spectrometry	25
2.4.4 Fourier transform infrared spectroscopy (FT-IR)	25
2.4.5 Fourier transform NMR spectroscopy (FT-NMR)	25
2.5 Crystal structure determination	26
2.5.1 Select a suitable crystal	28
2.5.2 Crystals mounting	28
2.5.3 Optical alignment	29
2.5.4 Data collection	30
2.6 X-ray diffractometry	30
	vii

CONTENTS (continued)

	Page
2.7 Structure determination and refinement	34
2.7.1 Obtaining unit cell geometry and symmetry	35
2.7.2 The measurement of intensities	36
2.7.3 Data reduction	36
3. RESULTS	40
3.1 The studies on preparation of complexes	40
3.2 Elemental analysis	42
3.3 X-ray fluorescence spectrometry	42
3.4 Infrared spectroscopy	52
3.5 ^1H NMR and ^{13}C NMR spectroscopy	57
3.6 Single crystal X-ray diffractometry	67
4. DISCUSSION	49
4.1 Preparation of complexes	49
4.2 Elemental analysis	49
4.3 X-ray fluorescence spectrometry	50
4.4 Infrared spectroscopy	50
4.5 ^1H NMR and ^{13}C NMR spectroscopy	55
4.6 X-ray structure determination	57
4.6.1 The structure of $[\text{CuCl}(\text{PPh}_3)_2(\text{ptu})](1)$ and $[\text{CuBr}(\text{PPh}_3)_2(\text{ptu})](2)$	57
4.6.2 The structure of $[\text{CuI}(\text{PPh}_3)_2(\text{ptu})](3)$	59
5. CONCLUSION	115
REFERENCES	117
APPENDIX	123
VITAE	147

LIST OF TABLES

Table	Page
1 Copper(I) complexes of substituted thioureas and and triphenylphosphine	21
2 The condition of preparation of complexes	40
3 The physical properties of ligands and complexes	41
4 The partial elemental analyses of the complexes	42
5 The crystallographic data for [CuX(PPh ₃) ₂ (ptu)] (X= Cl and Br)	68
6 Non-hydrogen interatomic distances of [CuCl(PPh ₃) ₂ (ptu)]	69
7 Non-hydrogen inerbond angles of [CuCl(PPh ₃) ₂ (ptu)]	72
8 Non-hydrogen interatomic distances of [CuBr(PPh ₃) ₂ (ptu)]	76
9 Non-hydrogen inerbond angles of [CuBr(PPh ₃) ₂ (ptu)]	79
10 The crystallographic data for [CuI(PPh ₃) ₂ (ptu)]	84
11 Non-hydrogen interatomic distances of [CuI(PPh ₃) ₂ (ptu)]	85
12 Non-hydrogen inerbond angles of [CuI(PPh ₃) ₂ (ptu)]	90
13 Major IR bands of ptu and it complexes (cm ⁻¹)	103
14 ¹ H NMR spectra data of the ligand ptu and complexes in DMSO- <i>d</i> ₆	106
15 ¹³ C NMR spectra data of the ligand ptu and complexes	107
16 The selected bond lengths (Å) and angles (°) of the studied compounds	113
17 Hydrogen-bonding geometry (Å, °)	114
18 The equation of calculation of unit cell volume depends on crystal system	122
19 Non-hydrogen atom coordinates and isotropic thermal parameters of [CuCl(PPh ₃) ₂ (ptu)]	125
20 Hydrogen atom coordinates and isotropic thermal parameters of [CuCl(PPh ₃) ₂ (ptu)]	128
21 Non-hydrogen thermal parameters of [CuCl(PPh ₃) ₂ (ptu)]	130
22 Non-hydrogen atom coordinates and isotropic thermal parameters of [CuBr(PPh ₃) ₂ (ptu)]	132
23 Hydrogen atom coordinates and isotropic thermal parameters of [CuBr(PPh ₃) ₂ (ptu)]	134

LIST OF TABLES (continued)

Table	Page
24 Non-hydrogen thermal parameters of [CuBr(PPh ₃) ₂ (ptu)]	136
25 Non-hydrogen atom coordinates and isotropic thermal parameters of [CuI(PPh ₃) ₂ (ptu)]	138
26 Non-hydrogen thermal parameters of [CuI(PPh ₃) ₂ (ptu)]	142

LIST OF ILLUSTRATIONS

Figure	Page
1 The structures of (a) thiourea (tu) and (b) <i>N</i> -phenylthiourea (ptu)	2
2 The tautomerism structure of thiourea	3
3 Various coordination modes of thioamides	3
4 The structure of triphenylphosphine (PPh ₃)	4
5 View of the molecule Cu ₂ Cl ₂ (PPh ₃) ₃ in the monoclinic crystal	6
6 View of the molecule Cu ₂ Br ₂ (PPh ₃) ₃ . The symbol, C, for each carbon atom has been omitted for clarity	7
7 A single molecule of Cu ₂ Br ₂ (PPh ₃) ₃	8
8 The structure of CuI(PPh ₃) ₃	8
9 A single molecule of trigonal [Cu(PPh ₃) ₃ Br] viewed down Cu-Br bond	9
10 A single molecule of [Cu(PPh ₃) ₃ Br]·2Me ₂ CO, projected down the Cu-Br bond	10
11 The structure of [Cu(PPh ₃) ₂ (pymtH)Br]	11
12 The structure of [Cu(tzdtH) ₂ (PPh ₃) ₂]NO ₃ with atom labels	12
13 The structure of [Cu(PPh ₃) ₂ (meimtH)Br]	12
14 The structure of [Cu(PPh ₃) ₂ (bzimtH ₂)Cl]	13
15 The structure of [Cu(PPh ₃) ₂ (pymtH)I]	14
16 The structure of [Cu(bztzdtH)(PPh ₃)Br] ₂	15
17 The structure of [Cu(PPh ₃) ₂ (tzdtH)Cl]	16
18 The structure of [Cu(PPh ₃) ₂ (bztzdtH)Cl]	17
19 The structure of (Ph ₃ P) ₂ Cu[PhC(S)NP(S)(OPr- <i>i</i>) ₂]	18
20 The structure of (Ph ₃ P) ₂ Cu[Et ₂ NC(S)NP(S)(OPr- <i>i</i>) ₂]	18
21 The structure of [PPh ₃ Cu(Tr ^{Mes,Me})]	19
22 The structure of [PPh ₃ Cu(Tr ^{Me,o-Py})]	20
23 A flowchart for the step involved in a crystal structure determination	27
24 Crystal mounting	29
25 The goniometer head	30

LIST OF ILLUSTRATIONS (continued)

Figure	Page
26 SMART APEX system components	31
27 SMART APEX & goniometer module instrumentation	32
28 Fixed χ , 3-axis goniometer	33
29 A flowchart of structure determination and refinement	35
30 The Cu(K_α) spectrum of [CuCl(PPh ₃) ₂ (ptu)]	43
31 The S(K_α), S(K_β), P(K_α) and P(K_β) spectrum of [CuCl(PPh ₃) ₂ (ptu)]	44
32 The Cl(K_α) spectrum of [CuCl(PPh ₃) ₂ (ptu)]	45
33 The Cu(K_α) spectrum of [CuBr(PPh ₃) ₂ (ptu)]	46
34 The S(K_α), S(K_β), P(K_α) and P(K_β) spectrum of [CuBr(PPh ₃) ₂ (ptu)]	47
35 The Br(K_α) and Br(K_β) spectrum of [CuBr(PPh ₃) ₂ (ptu)]	48
36 The Cu(K_α) spectrum of [CuI(PPh ₃) ₂ (ptu)]	49
37 The S(K_α), S(K_β), P(K_α) and P(K_β) spectrum of [CuI(PPh ₃) ₂ (ptu)]	50
38 The I(K_α) spectrum of [CuI(PPh ₃) ₂ (ptu)]	51
39 The infrared spectrum of <i>N</i> -phenylthiourea (ptu)	52
40 The infrared spectrum of Triphenylphosphine (PPh ₃)	53
41 The infrared spectrum of [CuCl(PPh ₃) ₂ (ptu)]	54
42 The infrared spectrum of [CuBr(PPh ₃) ₂ (ptu)]	55
43 The infrared spectrum of [CuI(PPh ₃) ₂ (ptu)]	56
44 ¹ H NMR spectrum of <i>N</i> -phenylthiourea (ptu)	57
45 ¹ H NMR spectrum of Triphenylphosphine (PPh ₃)	58
46 ¹ H NMR spectrum of [CuCl(PPh ₃) ₂ (ptu)]	59
47 ¹ H NMR spectrum of [CuBr(PPh ₃) ₂ (ptu)]	60
48 ¹ H NMR spectrum of [CuI(PPh ₃) ₂ (ptu)]	61
49 ¹³ C NMR spectrum of <i>N</i> -phenylthiourea (ptu)	62
50 ¹³ C NMR spectrum of Triphenylphosphine (PPh ₃)	63
51 ¹³ C NMR spectrum of [CuCl(PPh ₃) ₂ (ptu)]	64
52 ¹³ C NMR spectrum of [CuBr(PPh ₃) ₂ (ptu)]	65

LIST OF ILLUSTRATIONS (Continued)

Figure	Page
53 ^{13}C NMR spectrum of $[\text{CuI}(\text{PPh}_3)_2(\text{ptu})]$	66
54 The structure of $[\text{CuX}(\text{PPh}_3)_2(\text{ptu})]$ ($\text{X} = \text{Cl}$ and Br). Ellipsoids are drawn at the 50% probability level	83
55 Unit cell contents of $[\text{CuX}(\text{PPh}_3)_2(\text{ptu})]$ ($\text{X} = \text{Cl}$ and Br) projected down a . The hydrogen atoms are omitted for clarity	83
56 The structure of $[\text{CuI}(\text{PPh}_3)_2(\text{ptu})]$. Ellipsoids are drawn at the 50% probability level	97
57 Unit cell contents of $[\text{CuI}(\text{PPh}_3)_2(\text{ptu})]$ projected down a . The hydrogen atoms are omitted for clarity	98
58 The structures features a distorted tetrahedral of $[\text{CuX}(\text{PPh}_3)_2(\text{ptu})]$ ($\text{X} = \text{Cl}$ and Br complexes)	109
59 The structures features a distorted tetrahedral of $[\text{CuI}(\text{PPh}_3)_2(\text{ptu})]$ complexes. 50% Thermal ellipsoids are shown for the non-hydrogen atoms	110
60 The hydrogen-bonding geometry	111
61 A view of molecule B in $[\text{Cu}(\text{PPh}_3)_2(\text{ptu})\text{I}]$ with atom labels	112
62 The bravais Lattices	125

LIST OF ABBREVIATIONS AND SYMBOLS

°	=	degree
Å	=	Angstrom unit (1 Å = 10 ⁻¹⁰ metre)
°C	=	degree celsius
A.R.	=	Analytical Reagent
cm ⁻¹	=	wave number
D_c	=	calculated density
D_m	=	measured density
EDXRF	=	Energy Dispersive X-ray Fluorescence
g	=	gram
g/cm ³	=	gram per cubic centimetre
hr.	=	hour
K	=	Kelvin
KeV	=	kilo electron volt
mg	=	milligram
kg	=	kilogram
L.R.	=	Lab Reagent
mL	=	millilitre
mm.	=	milimetre
mmol	=	milimole
M	=	molar
V	=	volume
ptu	=	<i>N</i> -phenylthiourea
PPh ₃	=	triphenylphosphine
CuI	=	Copper(I) iodide
CuBr	=	Copper(I) bromide
CuCl	=	Copper(I) chloride
<i>s</i>	=	singlet
<i>m</i>	=	multiplet

LIST OF ABBREVIATIONS AND SYMBOLS (continued)

b	=	broad
nm	=	nanometre
mp.	=	melting point
cm ⁻¹	=	reciprocal centimetre (wave number)
δ	=	chemical shift relative to TMS
λ_{\max}	=	maximum absorption wavelength
λ	=	wavelength
ν	=	absorption frequency
ε	=	molar extinction coefficient
MHz	=	Megahertz
Hz	=	hertz
ppm	=	part per million
Fig.	=	Figure
IR	=	Infrared
UV-Vis	=	Ultraviolet-Visible
NMR	=	Nuclear magnetic resonance
DMSO- <i>d</i> ₆	=	hexadeutero-dimethyl sulphoxide

CHAPTER 1

Introduction

1.1 Introduction

Copper is a chemical element in the periodic table that has the symbol Cu and atomic number 29, is located in the periodic table between nickel and zinc in the first row of transition elements and in the same group as the other known as coinage metals, silver and gold. The electronic configuration of elemental copper is $[1s^2 2s^2 3s^2] 3d^{10} 4s^1$ or $[\text{Ar}] 3d^{10} 4s^1$. Copper has a single *s* electron outside the filled *3d* shell but essentially nothing in common with the alkalis except formal stoichiometries in the +1 oxidation state. It is a ductile metal with excellent electrical conductivity, and finds extensive use as an electrical conductor, as a building material, and as a component of various alloys. Copper is a reddish-coloured metal, with a high electrical and thermal conductivity (silver is the only pure metal to have a higher electrical conductivity at room temperature). In oxidation copper is mildly basic. Copper has its characteristic colour because it reflects red and orange light and absorbs other frequencies in the visible spectrum, due to its band structure. This can be contrasted with the optical properties of silver, gold and aluminium. Copper occupies the same family of the periodic table as silver and gold, because it shares many characteristics with these metals. All have very high thermal and electrical conductivity, and all are malleable metals. Copper is insoluble in water (H₂O) as well as in isopropanol, or isopropyl alcohol. There are two stable isotopes, ⁶³Cu and ⁶⁵Cu, along with a couple dozen radioisotopes. The vast majority of radioisotopes have half lives on the order of minutes or less; the longest lived, ⁶⁴Cu, has a half life of 12.7 hours, with two decay modes leading to two separate products.

Copper is essential in all higher plants and animals. Copper is carried mostly in the bloodstream on a plasma protein called ceruloplasmin. When copper is first absorbed in the gut it is transported to the liver bound to albumin. Copper is found in a variety of enzymes, including the copper centers of cytochrome c oxidase and the

enzyme superoxide dismutase (containing copper and zinc). In addition to its enzymatic roles, copper is used for biological electron transport (Michael *et al.*, 1996). The blue copper proteins that participate in electron transport include azurin and plastocyanin. The name "blue copper" comes from their intense blue color arising from a ligand-to-metal charge transfer (LMCT) absorption band around 600 nm.

Most molluscs and some arthropods such as the horseshoe crab use the copper-containing pigment hemocyanin rather than iron-containing hemoglobin for oxygen transport, so their blood is blue when oxygenated rather than red. In sufficient amounts, copper can be poisonous or even fatal to organisms.

The structure and stereochemistry of copper complexes have largely been influenced by the electronic configuration of the metal ion. Copper(I) is soft acceptor therefore it is well-coordinated with soft donor, a d^{10} configuration prefers a tetrahedral orientation; copper(II) complexes, a d^9 system, exhibit coordination number dependent structures: 4 coordination prefers square planar, the 5 coordinated system is square pyramidal or trigonal bipyramidal and 6 coordinated complexes are distorted octahedral.

Thiourea and substituted thioureas (or thioamides) are soft donor ligands. In addition, thiourea and its derivatives, such as *N*-phenylthiourea (ptu) can be inhibitors in the evaluation of the efficiency of some corrosion inhibitors used in the descaling solutions of the filmed carbon steel (Radulescu *et al.*, 2001). The structure of *N*-phenylthiourea and thiourea is shown in Figure 1.

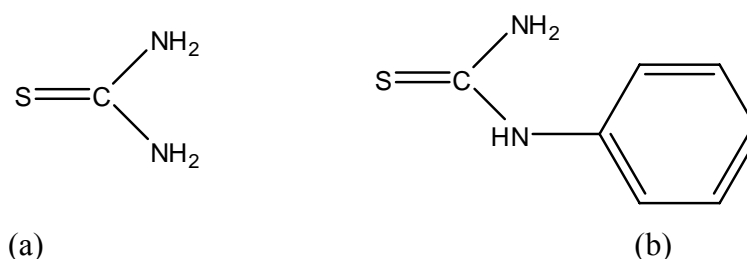

Figure 1 The structures of (a) thiourea (tu) and (b) *N*-phenylthiourea (ptu).

Thioamides are organic compounds containing the radical or group $-\text{CSNH}_2$. Thiourea and substituted thioureas have been shown to occur in the thione rather than the thiol form both in the solid state and in most of the common solvents, with only occasional striking exceptions (Figure 2).

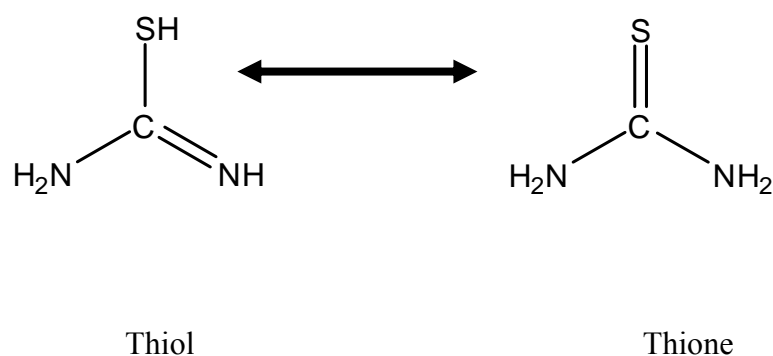

Figure 2 The tautomerism structure of thiourea.

Therefore *N*-phenylthiourea, the substituted thiourea in this work containing a thioamide structure has considerable potential is in thione form that indeed a considerable versatility in the coordination modes of these molecules which may include monodentate binding through S(I) or through N(II), bridging through a single S(III), bridging through both S and N(IV) or chelating via the S-to-N backbone (VI) (Pericles, 2001) (Figure 3).

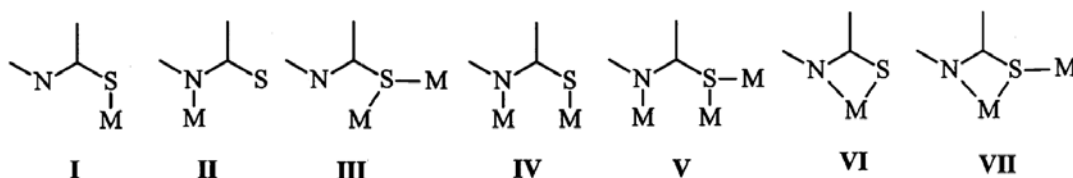

Figure 3 Various coordination modes of thioamides.

The substituted thiourea ligands are potentially capable of forming coordinate bonds through both sulfur and nitrogen. Both of these possibilities will be reflected in the infrared spectra of the complexes. Bonding through sulfur will decrease the bond order of the carbon-sulfur link towards the value for a single bond while the carbon-nitrogen bond approaches the value for a double bond. Hence, in such complexes, the C-S stretching frequency should decrease and that of C-N should increase. If, on the contrary, a nitrogen-metal bond is formed just the opposite effect is to be expected. Furthermore, the N-H frequency should decrease if the metal is coordinated through nitrogen, while remaining substantially unaffected if the bonding is through sulfur. (Swaminathan and Irving, 1964). The stereochemistry of Cu(I) thiourea and substituted thioureas complexes is interesting not only because of the variety of their structures but also because of similarity metallothioneines (Baumgartner *et al.*, 1993) that they contain Cu – S coordinated which are important role in animal and plants.

Triphenylphosphine (PPh₃) is widely used in organic synthesis. The properties that guide its usage are its nucleophilicity and its reducing character. The nucleophilicity of PPh₃ is indicated by its reactivity toward electrophilic alkenes, such as Michael-acceptors, and alkyl halides. The structure of triphenylphosphine is shown in Figure 4.

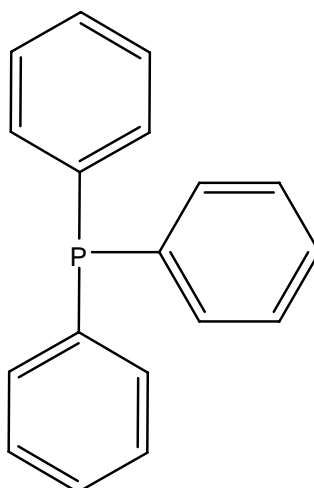

Figure 4 The structure of triphenylphosphine (PPh₃).

For both kind of ligands, owing to their relevance in biological systems, substituted thioureas and triphenylphosphine have attracted considerable attention as ligands in metal complexes. In the course of this investigation, whose major target was the study of the factors that govern the coordination geometry of the metal atom. Although the interplay of several parameters like the geometrical flexibility of the coinage metals and electronic properties or bulkiness on the part of the ligands make structural prediction of these complexes virtually impossible, steric demands of the phosphine ligands seems to be of major importance causing significant changes on the coordination geometry of the metal atom (Hadjikakou *et al.*, 1992). In this work, the structures of copper(I) halide complexes with triphenylphosphine (PPh₃) and *N*-phenylthiourea (ptu) have been reported. Their complexes can be readily obtained by the addition of *N*-phenylthiourea ligand to a CuX-phosphine (CuX ;X=Cl, Br, I) adduct in a solution.

1.2 Literature reviews

Copper(I) halides with monodentate phosphine ligand form complexes of the type [XCuL_n] where X= Cl, Br, I; L= monodentate phosphine ligand, and n can vary in the range 1 to 3 i.e. L₃Cu₂X₂, L₂CuX, L₃CuX (n= 1.5, 2, 3) as in the following works.

Albano and co-worker (Albano *et al.*, 1972) studied the crystal structure of the Cu₂Cl₂(PPh₃)₃ that has been determined from three-dimensional X-ray data collected by counter method. The crystals are monoclinic, space group *P2*₁/*c*, with *Z* = 4 in a unit cell of dimensions *a* = 19.27(2), *b* = 9.8(1), *c* = 27.02(3) Å, β = 112.5(8)°. The crystal contains discrete molecules in which two copper atoms are held together by chlorine bridges.

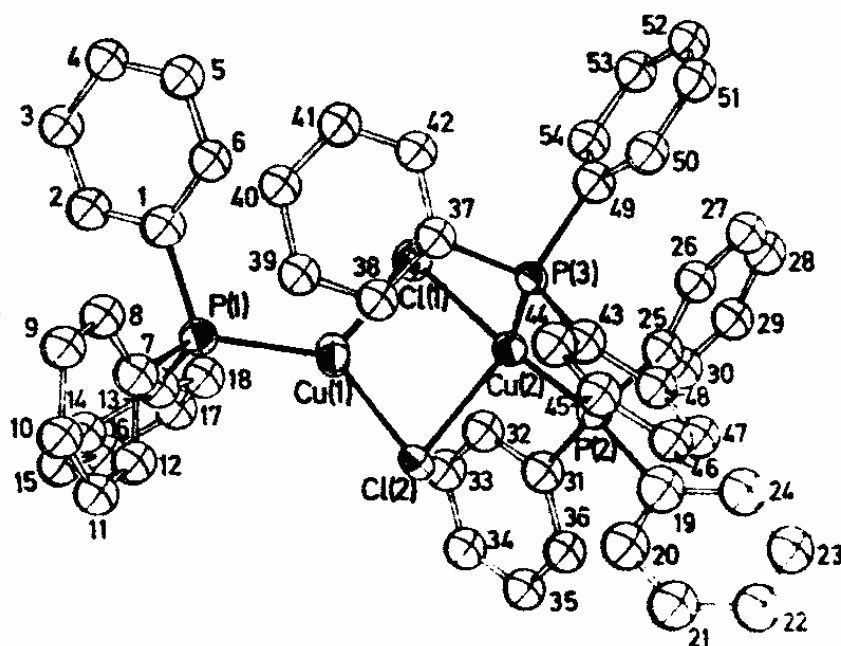

Figure 5 The molecular structure $\text{Cu}_2\text{Cl}_2(\text{PPh}_3)_3$ in the monoclinic crystal. Hydrogen atoms have been omitted for clarity.

Negita and co-worker (Negita *et al.*, 1981) studied the crystal structure of the $\text{Cu}_2\text{Br}_2(\text{PPh}_3)_3 \cdot 1.5\text{C}_6\text{H}_6$ complex by three dimensional X-ray analysis. The complex crystallines in the monoclinic space group is $P2_1/c$ with unit-cell parameters of $a = 14.122(3)$, $b = 19.573(4)$, $c = 25.985(7)$ Å, $\beta = 128.99(1)^\circ$ and $Z = 4$. The structure of $\text{Cu}_2\text{Br}_2(\text{PPh}_3)_3$ consists of both three- and four-coordinated copper atoms as shown in Figure 6.

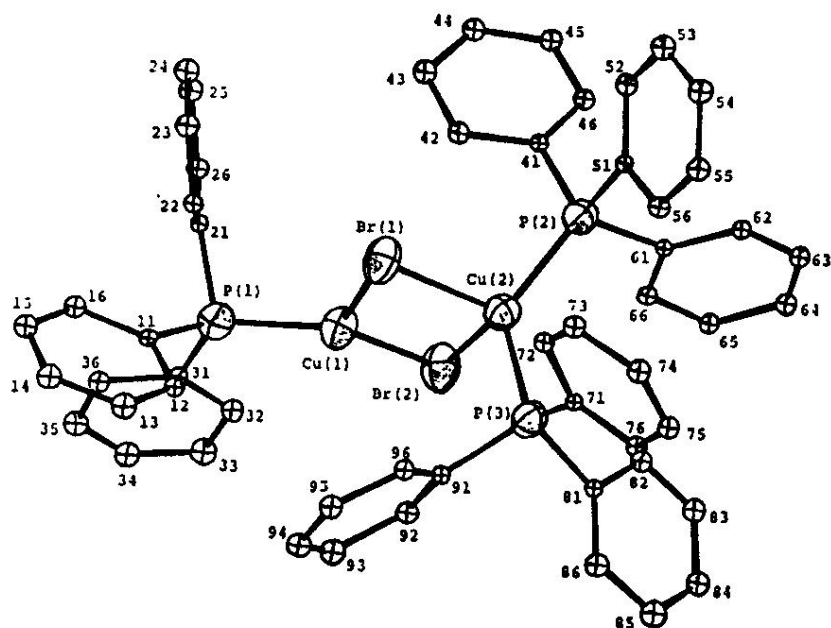

Figure 6 The molecular structure of $\text{Cu}_2\text{Br}_2(\text{PPh}_3)_3$. Hydrogen atoms have been omitted for clarity.

Dyason and co-worker (Dyason *et al.*, 1985) studied the crystal structure of $(\text{PPh}_3)_2\text{CuBr}_2\text{Cu}(\text{PPh}_3)$ and found that $(\text{PPh}_3)_2\text{CuBr}_2\text{Cu}(\text{PPh}_3)$ complex crystallines in the monoclinic space group $P2_1/c$ with $a = 19.390(8)$, $b = 9.912(5)$, $c = 26.979(9)$ Å, $\beta = 112.33(3)^\circ$; $R = 0.043$ for $N_o = 3444$. Cu (trigonal)-P; Br are 2.191(3): 2.409(2), 2.364(2) Å, respectively, Cu (tetrahedral)-P; Br are 2.241(3): 2.249(3), 2.550(2), 2.571(2) Å, respectively.

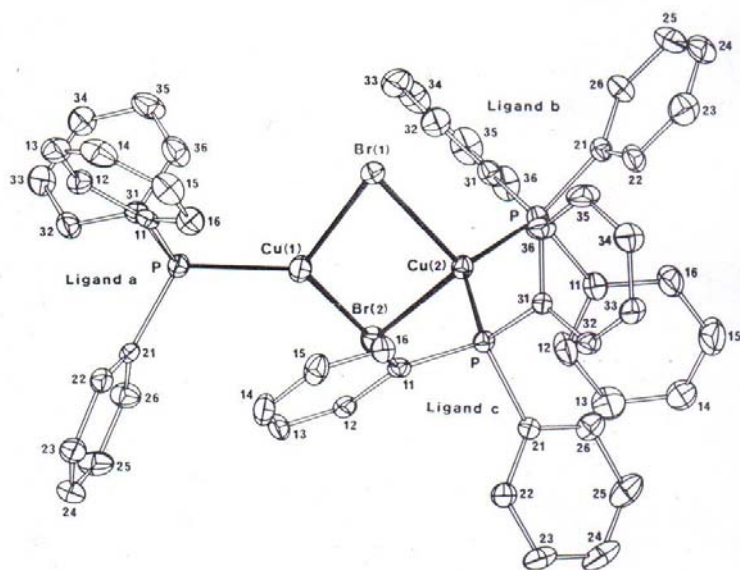

Figure 7 A single molecule of $\text{Cu}_2\text{Br}_2(\text{PPh}_3)_3$.

Barron and co-worker (Barron *et al.*, 1987) studied the crystal structures of copper(I) halides (CuX ; $\text{X} = \text{Br}, \text{I}$) and triphenylphosphine, CuIL_3 , CuL_3Br and $[\text{CuL}_3\text{Br}] \cdot 2\text{Me}_2\text{CO}$. ($\text{L} = \text{triphenylphosphine}, \text{PPh}_3$) as shown in Figures 8-10.

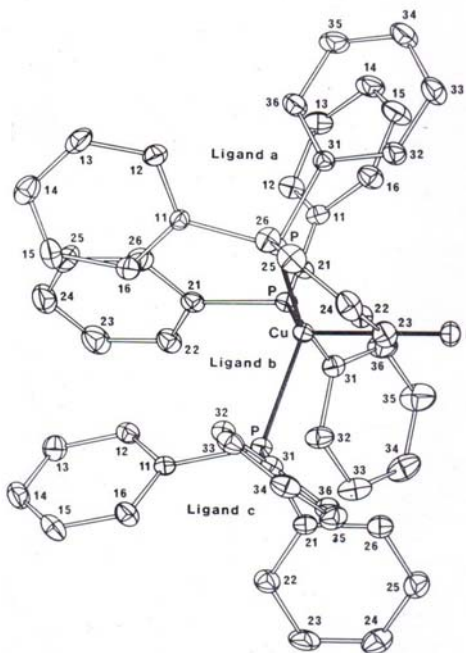

Figure 8 The molecular structure of $\text{CuI}(\text{PPh}_3)_3$. Hydrogen atoms have been omitted for clarity.

Crystal data: triclinic, space group $P\bar{1}$ with $a = 14.646(5)$, $b = 14.471(6)$, $c = 13.249(5)$ Å, $\alpha = 87.91(3)$, $\beta = 84.28(3)$, $\gamma = 71.85(3)^\circ$ and $Z = 2$.

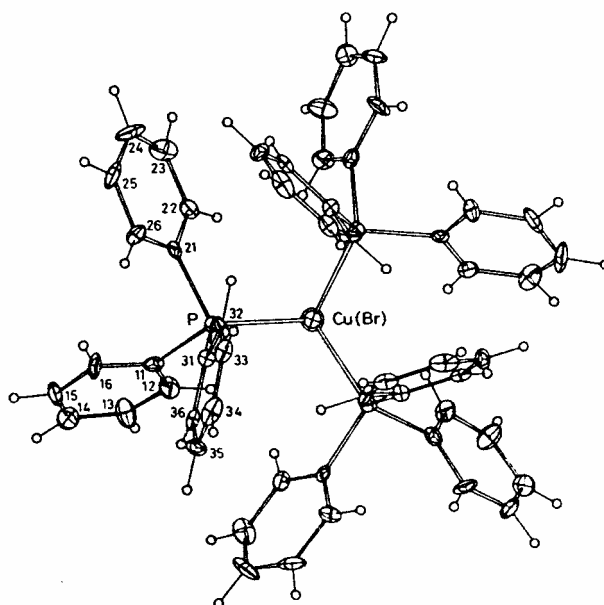

Figure 9 A single molecule of trigonal $[\text{Cu}(\text{PPh}_3)_3\text{Br}]$ viewed down Cu-Br bond.

Crystal data: trigonal, space group $P3$ (C_3^1 , no. 143), $a = 19.225(8)$, $c = 10.610(3)$ Å, $V = 3.397(2)$ Å³ and $Z = 2$.

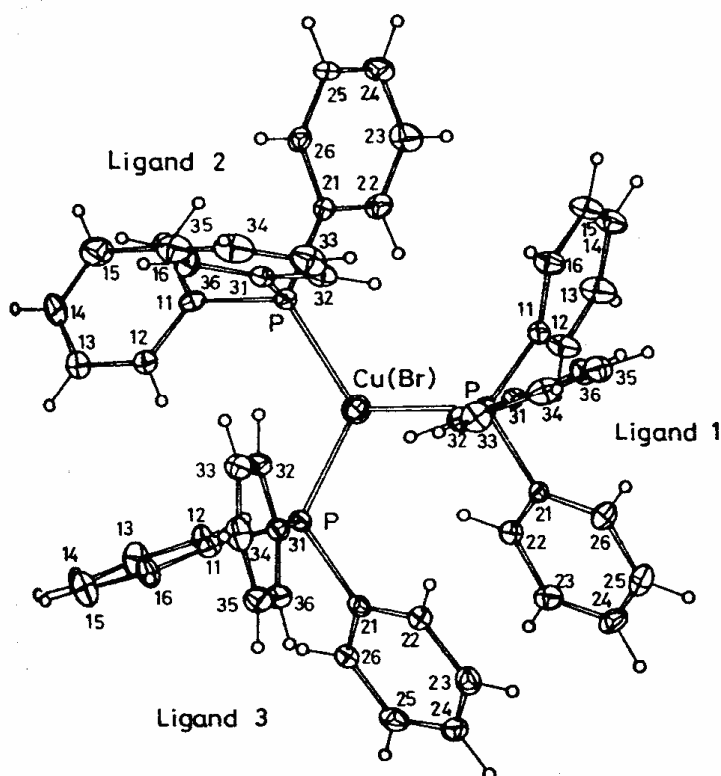

Figure 10 A single molecule of $[\text{Cu}(\text{PPh}_3)_3\text{Br}] \cdot 2\text{Me}_2\text{CO}$, projected down the Cu-Br bond.

Crystal data: triclinic, space group $P\bar{1}$, $a = 14.565(3)$, $b = 14.412(4)$, $c = 13.262(4)$ Å, $\alpha = 87.82(2)$, $\beta = 83.82(2)$, $\gamma = 71.80(2)^\circ$ and $Z = 2$.

Copper(I) halides also form mixed PPh_3 /sulfur or nitrogen base complexes. These complexes may be described as being of the type: copper halide: PPh_3 : sulfur base ligand = 1: 2: 1 or 1: 2: 2 or 1: 1: 1 as follows:

Lecomte and co-workers (Lecomte *et al.*, 1989) studied the reaction of copper(I) bromide with pyrimidine-2-thione (pymtH) in the presence of triphenylphosphine yielded mononuclear complex of the formula $[\text{Cu}(\text{pymtH})(\text{PPh}_3)_2\text{Br}]$. The complex was characterized by elemental analysis, IR,

UV-Vis and NMR spectroscopy. The crystal structure of $[\text{Cu}(\text{PPh}_3)_2(\text{pymtH})\text{Br}]$ was determined by single-crystal X-ray diffraction method.

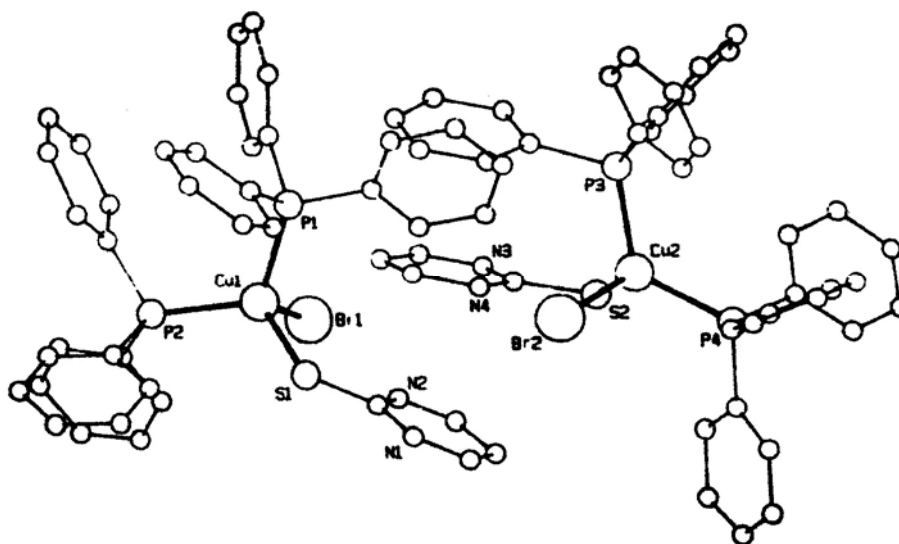

Figure 11 The structure of $[\text{Cu}(\text{PPh}_3)_2(\text{pymtH})\text{Br}]$. Hydrogen atoms have been omitted for clarity.

Crystal data: monoclinic, space group $P2_1/n$ with $a = 13.035(2)$, $b = 43.660(9)$, $c = 13.446(2)$ Å, $\beta = 90.68(2)^\circ$, and $D_{\text{calc}} = 1.352$ g cm $^{-3}$, $V = 7652$ Å 3 , $R(F) = 0.067$; $R_w(F) = 0.069$, $GOF = 1.19$. In both molecules of the asymmetric unit, the pymtH molecule acts as a monodentate ligand through the S atom (Cu-S = 2.352(3) Å).

Karagiannidis and co-workers (Karagiannidis *et al.*, 1989) studied the reactions of bis(triphenylphosphine)copper(I) nitrate with 1,3-thiazolidine-2-thione (tzdtH) lead to the formation of mononuclear complex of $[\text{Cu}(\text{tzdtH})_2(\text{PPh}_3)_2]\text{NO}_3$. The complex was characterized by elemental analysis, infrared, UV-Vis, NMR spectroscopy and single-crystal X-ray diffraction method.

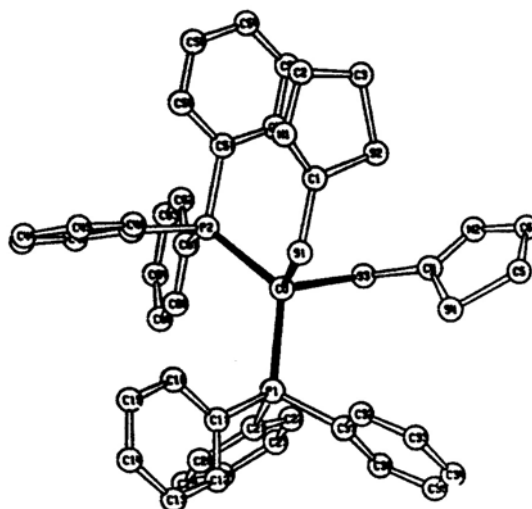

Figure 12 The molecular structure of $[\text{Cu}(\text{tzdtH})_2(\text{PPh}_3)_2]\text{NO}_3$ with atom labels.

Crystal data: monoclinic, space group $P2_1/c$ with $a = 16.314(2)$, $b = 9.981(2)$, $c = 25.799(3)$ Å, $\beta = 89.39(1)^\circ$, $V = 4200$ Å³ and $Z = 4$.

Karagiannidis and co-workers (Karagiannidis *et al.*, 1990) studied the copper(I) mixed-ligand complexes with 1-methyl-1,3-imidazoline-2-thione (meimtH) and triphenylphosphine of the general formula $[\text{Cu}(\text{PPh}_3)_2(\text{meimtH})\text{X}]$ [$\text{X} = \text{Cl}, \text{Br}, \text{I}$], and their characterization by various physico-chemical methods. The crystal structure of the complex $[\text{Cu}(\text{PPh}_3)_2(\text{meimtH})\text{Br}]$ was determined by single-crystal X-ray diffraction method.

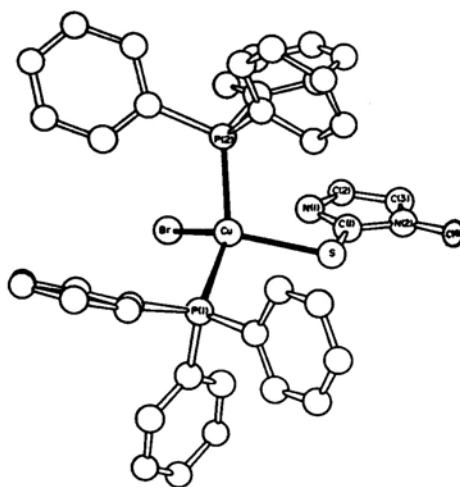

Figure 13 The molecular structure of $[\text{Cu}(\text{PPh}_3)_2(\text{meimtH})\text{Br}]$.

[Cu(PPh₃)₂(meimtH)Br] complex crystallines in the space group $P\bar{1}$ with $a = 9.988(3)$, $b = 10.212(2)$, $c = 21.066(5)$ Å, $\alpha = 94.86(2)$, $\beta = 91.70(2)$, $\gamma = 119.16(2)^\circ$ and $Z = 2$. The copper ion has a distorted tetrahedral geometry with bond lengths Cu-S = 2.375(1), Cu-Br = 2.509(0), Cu-P(1) = 2.268(1) and Cu-P(2) = 2.281(1) Å.

Skoulika and co-workers (Skoulika *et al.*, 1991) studied the copper(I) chloride complex with benz-1,3-imidazoline-2-thione(bzimtH₂) and triphenylphosphine as ligands, [Cu(PPh₃)₂(bzimtH₂)Cl], and characterized this complex by elemental analysis, IR, UV-Vis and NMR spectroscopies. Crystal structure of the this complex was determined by X-ray analysis.

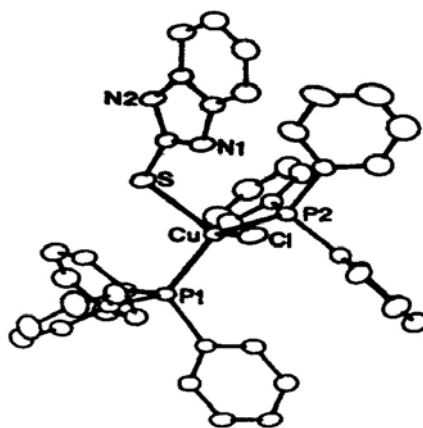

Figure 14 The molecular structure of [Cu(PPh₃)₂(bzimtH₂)Cl].

Crystal data: monoclinic, space group $P2_1/c$ with $a = 13.147(2)$, $b = 18.592(3)$, $c = 17.259(3)$ Å, $\beta = 97.45(2)^\circ$, $Z = 4$. The final R value is 0.036 ($R_w = 0.036$, GOF = 1.8).

Aslanidis and co-workers (Aslanidis *et al.*, 1993) studied the reaction of [Cu(PPh₃)I]₄ with pyrimidine-2-thione(pymtH) in the presence of triphenylphosphine to give mononuclear complex of [Cu(PPh₃)₂(pymtH)I]. This complex was characterized by various physicochemical methods.

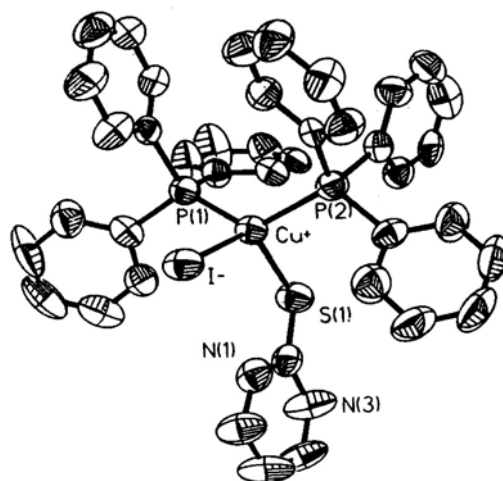

Figure 15 The molecular structure of $[\text{Cu}(\text{PPh}_3)_2(\text{pymtH})\text{I}]$.

Crystal data: monoclinic, space group $P2_1/n$ with $a = 9.708(2)$, $b = 19.838(4)$, $c = 19.893(4)$ Å, $\beta = 92.53(3)^\circ$, $Z = 4$. The molecule is mononuclear, with a distorted tetrahedral geometry and bond lengths $\text{Cu-S} = 2.338(4)$, $\text{Cu-I} = 2.674(2)$, $\text{Cu-P} = 2.296(4)$ and $2.303(4)$ Å.

Jianping and co-workers (Jianping and Kazuyuki, 1996) studied the reaction of CuBr , triphenylphosphine (PPh_3) and benz-1,3-thiazolidine-2-thione (bztzdtH) yielded the complex, $[\text{Cu}(\text{bztzdtH})(\text{PPh}_3)\text{Br}]_2$ and its structure was determined by single-crystal X-ray diffraction method. The sulfur atoms of two bztzdtH ligands link the two copper atoms, forming a planar Cu_2S_2 moiety with $\text{Cu-S}(1) = 2.514(1)$, $\text{Cu-S}(1a) = 2.335(1)$ and $\text{Cu-Cu}(a) = 2.928(1)$ Å.

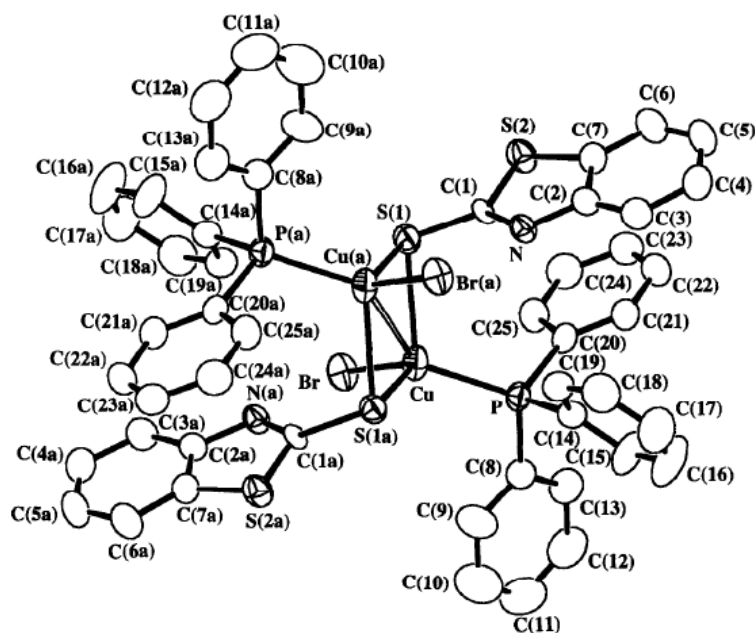

Figure 16 The molecular structure of $[\text{Cu}(\text{bztzdtH})(\text{PPh}_3)\text{Br}]_2$. Hydrogen atoms have been omitted for clarity.

Crystal data: monoclinic, space group $C2/c$, with $a = 25.991(14)$, $b = 9.206(1)$, $c = 19.943(3)$ Å, $\beta = 100.02(1)^\circ$, $Z = 4$, $R = 0.033$.

Aslanidis and co-workers (Aslanidis *et al.*, 1998) studied the reaction of $[\text{Cu}(\text{PPh}_3)_3\text{Cl}]$ with 1,3-thiazolidine-2-thione(tzdtH) yielded mononuclear complex of the formula $[\text{Cu}(\text{PPh}_3)_2(\text{tzdtH})\text{Cl}]$. The complex was characterized by various physicochemical methods and the structure was determined by single-crystal X-ray diffraction method.

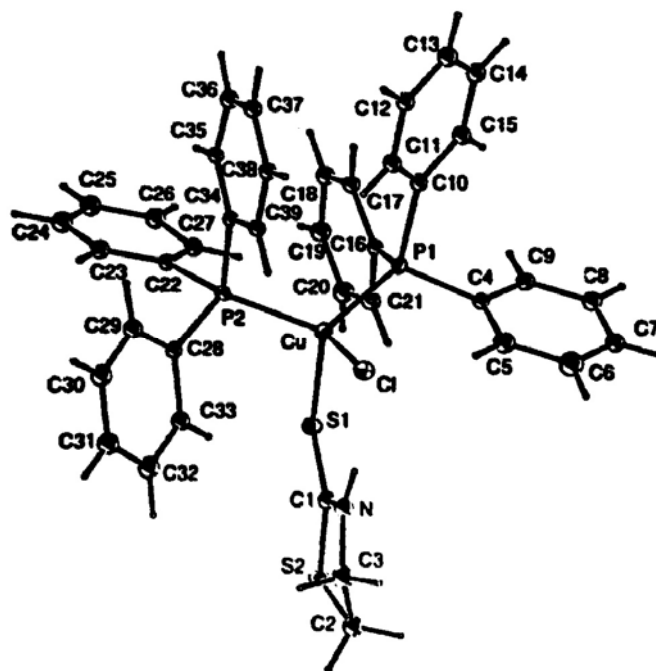

Figure 17 The molecular structure of $[\text{Cu}(\text{PPh}_3)_2(\text{tzdtH})\text{Cl}]$.

Crystal data: monoclinic, space group $P2_1/c$ with $a = 14.31(2)$, $b = 10.009(10)$, $c = 24.52(2)$ Å, $\beta = 93.53(7)^\circ$, $Z = 4$, $R = 0.0562$. The copper atom has a pseudo-tetrahedral geometry with bond lengths $\text{Cu-S} = 2.4181(5)$, $\text{Cu-Cl} = 2.344(3)$, $\text{Cu-P}(1) = 2.287(3)$ and $\text{Cu-P}(2) = 2.298(2)$ Å.

Cox and co-workers (Cox *et al.*, 1999) studied the treatment of $[\text{Cu}(\text{PPh}_3)_3\text{Cl}]$ ($\text{PPh}_3 =$ triphenylphosphine) in acetonitrile/methanol solvent with benz-1,3-thiazolidine-2-thione (bztzdtH) yielded mononuclear complex of $[\text{Cu}(\text{PPh}_3)_2(\text{bztzdtH})\text{Cl}]$. The complex was characterized by IR, UV-Vis and $^1\text{H-NMR}$ spectroscopic data. The structure by single crystal X-ray diffraction method is shown in Figure 18. In the molecule, copper(I) atom displays a distorted tetrahedral environment.

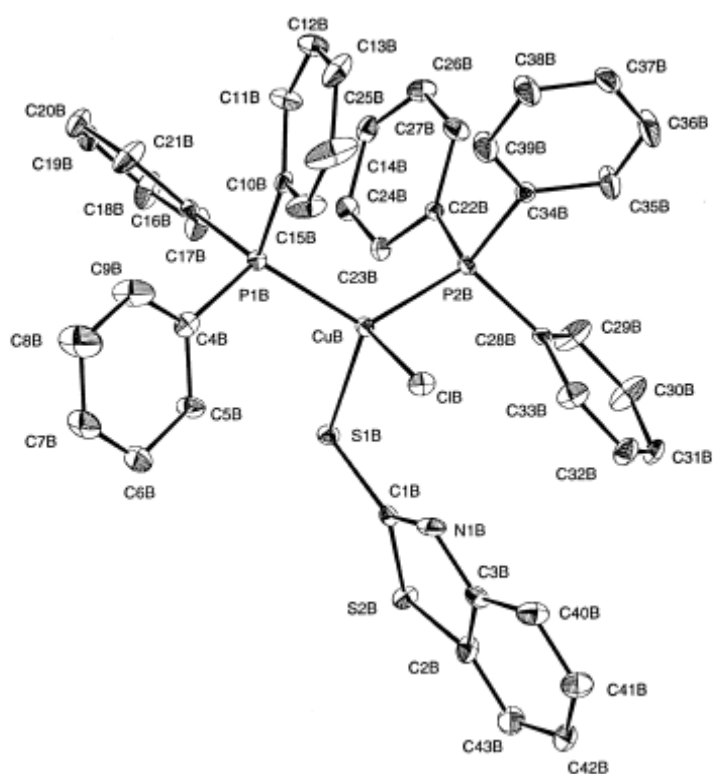

Figure 18 The molecular structure of $[\text{Cu}(\text{PPh}_3)_2(\text{bztzdtH})\text{Cl}]$. Hydrogen atoms have been omitted for clarity.

Crystal data: triclinic, space group $P\bar{1}$ with $a = 9.998(5)$, $b = 20.313(10)$, $c = 20.874(7)$ Å, $\alpha = 82.93(6)$, $\beta = 77.99(8)$, $\gamma = 83.60(3)^\circ$, $Z = 2$, $R = 0.060$ and $R_w = 0.0399$.

Alexander and co-workers (Alexander *et al.*, 2006) studied the heteroligand copper(I) complexes of *N*-thioacylamido(thio)phosphates and triphenylphosphine. Copper is bound by two PPh_3 and one SCNPX ($X = \text{O}, \text{S}$) fragment of chelating ligand in all cases. Triphenylphosphine molecules reversibly dissociate in solution. The molecular structures of $(\text{Ph}_3\text{P})_2\text{Cu}[\text{PhC}(\text{S})\text{NP}(\text{S})(\text{OPr-}i)_2]$ and $(\text{Ph}_3\text{P})_2\text{Cu}[\text{Et}_2\text{NC}(\text{S})\text{NP}(\text{S})(\text{OPr-}i)_2]$ are shown in Figures 19 and 20.

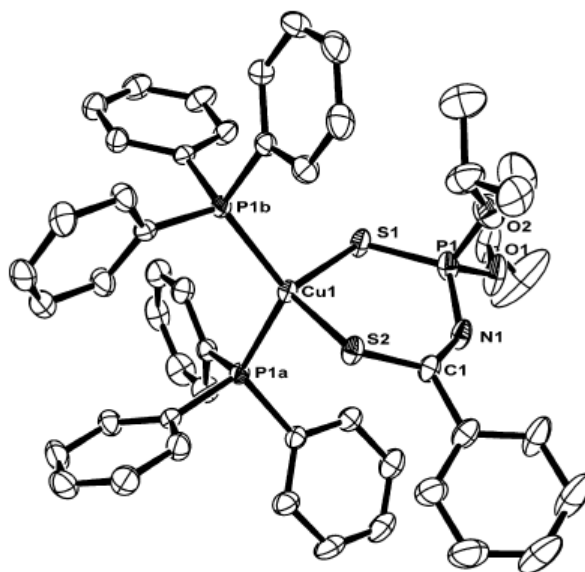

Figure 19 The molecular structure of $(\text{Ph}_3\text{P})_2\text{Cu}[\text{PhC}(\text{S})\text{NP}(\text{S})(\text{OPr-}i)_2]$.

Crystal data: space group $P\bar{1}$ with $a = 12.092(2)$, $b = 12.053(2)$, $c = 18.899(4)$ Å, $\alpha = 98.25(2)$, $\beta = 104.12(2)$, $\gamma = 114.65(2)^\circ$, $V = 2332.26$ Å³, $Z = 2$, $R = 0.039$.

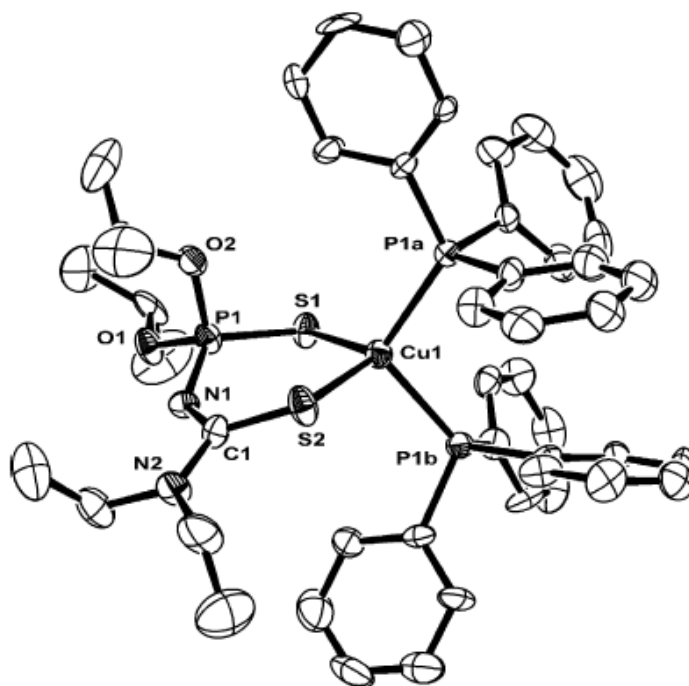

Figure 20 The molecular structure of $(\text{Ph}_3\text{P})_2\text{Cu}[\text{Et}_2\text{NC}(\text{S})\text{NP}(\text{S})(\text{OPr-}i)_2]$.

Crystal data: space group $P2_1/n$ with $a = 13.058(2)$, $b = 20.931(2)$, $c = 17.560(6)$ Å, $\alpha = 90.00(2)$, $\beta = 109(2)$, $\gamma = 90.00(2)^\circ$, $V = 4538(1)$ Å³, $Z = 4$, $R = 0.040$.

Marcello and co-workers (Marcello *et al.*, 2006) studied the complexes of $[\text{PPh}_3\text{Cu}(\text{Tr}^{\text{Mes,Me}})]$ and $[\text{PPh}_3\text{Cu}(\text{Tr}^{\text{Me,o-Py}})]$ ($\text{Tr}^{\text{Mes,Me}} = \text{hydrotris}[1,4\text{-dihydro-3-methyl-4-mesityl-5-thioxo-1,2,4-triazolyl}]$ borate; $\text{Tr}^{\text{Me,o-Py}} = \text{hydrotris}[1,4\text{-dihydro-4-methyl-3-(2-pyridyl)-5-thioxo-1,2,4-triazolyl}]$ borate; $\text{PPh}_3 = \text{triphenylphosphine}$) synthesized by the reaction of dinuclear complexes $[\text{Cu}(\text{Tr}^{\text{Mes,Me}})]_2$ and $[\text{Cu}(\text{Tr}^{\text{Me,o-Py}})]_2$, with PPh_3 respectively. The complexes were characterized by ^1H , ^{13}C , and ^{31}P NMR spectroscopy and ESI-mass spectrometry. The crystal structures were determined by single crystal X-ray diffraction method.

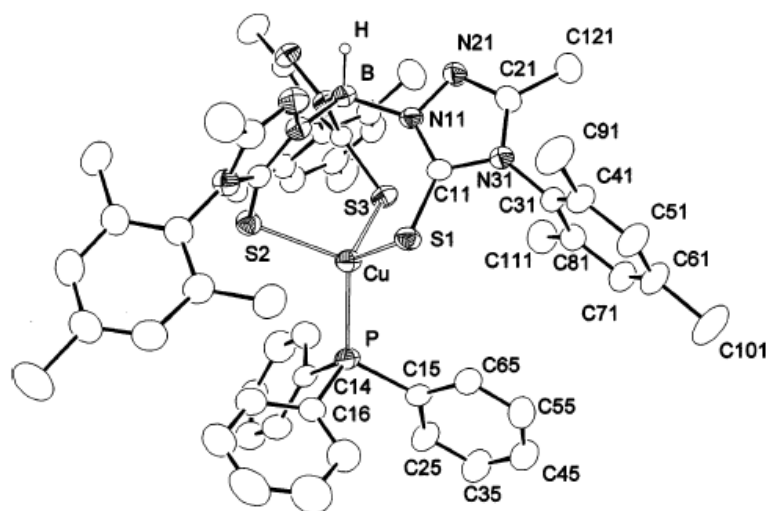

Figure 21 The molecular structure of $[\text{PPh}_3\text{Cu}(\text{Tr}^{\text{Mes,Me}})]$.

Crystal data: triclinic space group $P\bar{1}$ with $a = 12.328(1)$, $b = 12.901(1)$, $c = 24.666(2)$ Å, $\alpha = 77.466(1)$, $\beta = 79.834(1)$, $\gamma = 75.178(1)^\circ$, $V = 3671.5(5)$ Å³, $Z = 2$ and $R = 0.0551$.

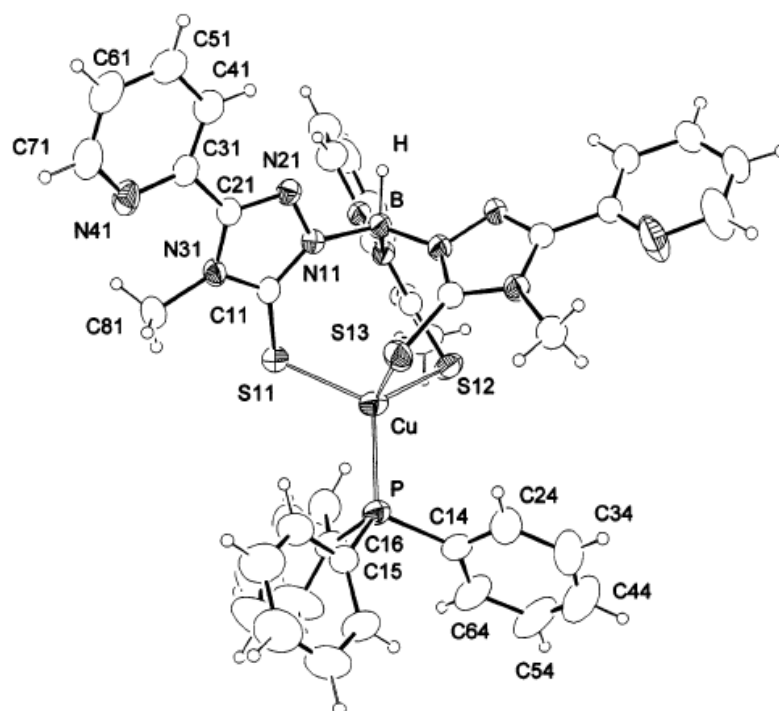

Figure 22 The molecular structure of $[\text{PPh}_3\text{Cu}(\text{Tr}^{\text{Me,o-Py}})]$.

Crystal data: triclinic space group $P\bar{1}$ with $a = 10.573(1)$, $b = 13.571(1)$, $c = 38.381(2)$ Å, $\alpha = 106.265(2)$, $\beta = 97.971(2)$, $\gamma = 104.757(2)^\circ$, $V = 2384.9(4)$ Å³, $Z = 2$, $R = 0.0465$.

The X-ray crystal structures of copper(I) complexes with triphenylphosphine and copper(I) complexes with mixed triphenylphosphine-thioamide have been previously studied are summarized in Table 1.

As a contribution to this field of research, the mixed ligand copper(I) halide complexes contain both substituted thiourea and triphenylphosphine ligands have been studied. Considering that neutral thiourea molecule with both nitrogen and sulfur as potential donating atoms can be coordinated to a metal in rich variety of ways, the copper(I) center is bound exclusively through the exocyclic sulfur atom either in a terminal or bridging mode. So the study of copper(I) with thiourea derivative and triphenylphosphine is interested in unpredicted structure.

Table 1 Copper(I) complexes of substituted thioureas and and triphenylphosphine.

Formula	Metal Stereochemistry	Reference
$\text{Cu}_2\text{Cl}_2(\text{PPh}_3)_3$	Cubane	Albano, 1972
$\text{Cu}_2\text{Br}_2(\text{PPh}_3)_3 \cdot 1.5\text{C}_6\text{H}_6$	Cubane	Negita, 1981
$\text{Cu}_2\text{Br}_2(\text{PPh}_3)_3$	Cubane	Barron, 1987
$\text{CuI}(\text{PPh}_3)_3$	Tetrahedral	
$[\text{Cu}(\text{PPh}_3)_3\text{Br}]$	Tetrahedral	
$[\text{Cu}(\text{PPh}_3)_3\text{Br}] \cdot 2\text{Me}_2\text{CO}$	Tetrahedral	
$[\text{Cu}(\text{PPh}_3)_2(\text{pymtH})\text{Br}]$	Tetrahedral	Lecomte, 1989
$[\text{Cu}(\text{tzdtH})_2(\text{PPh}_3)_2]\text{NO}_3$	Distorted tetrahedral	Karagiannidis, 1989
$[\text{Cu}(\text{PPh}_3)_2(\text{meimtH})\text{Br}]$	Distorted tetrahedral	Karagiannidis, 1990
$[\text{Cu}(\text{PPh}_3)_2(\text{bzimtH}_2)\text{Cl}]$	Tetrahedral	Skoulika, 1991
$[\text{Cu}(\text{PPh}_3)_2(\text{pymtH})\text{I}]$	Distorted tetrahedral	Aslanidis, 1993
$[\text{Cu}(\text{bztzdtH})(\text{PPh}_3)_2\text{Br}]_2$	Pseudo-tetrahedral	Jianping, 1996
$[\text{Cu}(\text{PPh}_3)_2(\text{tzdtH})\text{Cl}]$	Pseudo-tetrahedral	Aslanidis, 1998
$[\text{Cu}(\text{PPh}_3)_2(\text{bztzdtH})\text{Cl}]$	Distorted tetrahedral	Cox, 1999
$(\text{Ph}_3\text{P})_2\text{Cu}[\text{PhC}(\text{S})\text{NP}(\text{S})(\text{OPr-i})_2]$	Tetrahedral	Alexander, 2006
$(\text{Ph}_3\text{P})_2\text{Cu}[\text{Et}_2\text{NC}(\text{S})\text{NP}(\text{S})(\text{OPr-i})_2]$	Tetrahedral	
$[\text{PPh}_3\text{Cu}(\text{Tr}^{\text{Mes,Me}})]$	distorted tetrahedral	Marcello, 2006
$[\text{PPh}_3\text{Cu}(\text{Tr}^{\text{Me,o-Py}})]$	distorted tetrahedral	

1.3 Objectives

1. To study the method and find the optimum condition for synthesizing Cu(I) complexes with mixed ligands of triphenylphosphine and phenylthiourea by varying mole ratio of reactants, solvents, temperature of reaction and so on.
2. To synthesize and characterize the structures of these complexes by single crystal diffraction technique, IR, NMR and XRF spectroscopies.
3. To study molecular structure, arrangement of the molecules in unit cell, including crystal system, cell parameters and space group of the complexes.
4. To be the fundamental informations for other researcher who take them to find more applications.
5. To present the research in academic conferences or publish in chemistry journals.

CHAPTER 2

Experiment

2. Method of study

2.1 Materials and Instruments

1. Thermometer, Gallenkamp, England 0-360 °C
2. Capillary tube
3. Capillary melting point apparatus, Thomas Hoover, Unimelt 0-360 °C
4. Hot plate stirrer with magnetic bar
5. X-ray fluorescence spectrometer model PW 2400, Philips
6. Fourier transform infrared spectrometer, model 783, Perkin - Elmer
7. Fourier transform NMR spectrometer 500 MHz, Model UNITY INOVA, Varian
8. Bruker SMART APEX CCD diffractometer
9. UHU epoxy adhesive
10. Fiber glass, 0.1-0.4 mm. (in diameter)
11. Bee wax

2.2 Chemicals

Products of Fluka Chemical, Buchs, Switzerland

N-Phenylthiourea, C₇H₈N₂S, purum
Triphenylphosphine, C₁₈H₁₈P, purum
Copper(I) bromide, CuBr, L.R. grade
Copper(I) chloride, CuCl, L.R. grade

Products of Lab-Scan Analytical Science

Ethanol, C₂H₅OH, A.R. grade
Acetonitrile, CH₃CN, A.R. grade
Ethylacetate, C₄H₈O₂, A.R. grade

Products of Aldrich Chemical Company, Inc

Copper(I) iodide, CuI, L.R. grade

2.3 Preparation of complexes**2.3.1 Preparation of [CuCl(ptu)(PPh₃)₂] complex**

Triphenylphosphine (0.27g, 1.03 mmol) was dissolved in 30 cm³ of mixed-solvent of ethanol and ethyl acetate at 70-75 °C. CuCl (0.1g, 1.01 mmol) was added. The mixture was stirred for 3 hours during that time a greenish precipitate was formed. *N*-phenylthiourea (0.46 g, 3.02 mmol) was added and the new reaction mixture was heated under reflux for 4 hours where upon the precipitate gradually disappeared. The resulting clear solution was filtered off and left to evaporate at room temperature. The microcrystalline solids, which were deposited upon standing for several days, were filtered off and dried in vacuo.

2.3.2 Preparation of [CuBr(ptu)(PPh₃)₂] complex

Triphenylphosphine (0.27g, 1.03 mmol) was dissolved in 30 cm³ of mixed-solvent between ethanol and acetonitrile at 70-75 °C. CuBr (0.1g, 0.70 mmol) was added. The mixture was stirred for 2 hours during that time a greenish precipitate was formed. *N*-phenylthiourea (0.27g, 1.77 mmol) was added and the new reaction mixture was heated under reflux for 3 hours where upon the precipitate gradually disappeared. The resulting clear solution was filtered off and left to evaporate at room temperature. The microcrystalline solids, which were deposited upon standing for several days, were filtered off and dried in vacuo.

2.3.3 Preparation of [CuI(ptu)(PPh₃)₂] complex

Triphenylphosphine (0.27g, 1.03 mmol) was dissolved in 30 cm³ of acetonitrile at 70-75 °C. CuI (0.1g, 0.53 mmol) was added and mixture was stirred for 2 hours. After the formation of a complete clear solution, *N*-phenylthiourea (0.24 g, 1.58 mmol) was added slowly and the new reaction mixture was heated with

continuous stirring for 3 hours. The resulting clear solution was filtered off and left to evaporate at room temperature. The microcrystalline solids, which were deposited upon standing for several days, were filtered off and dried in vacuo.

2.4 Methods for Determination Structures

2.4.1 Melting Point Measurement

Melting points of the complexes were measured on Capillary Melting Point Apparatus, Thomas Hoover, Unimelt 0-360 °C.

2.4.2 Elemental Analysis

Carbon, hydrogen, nitrogen, sulfur and phosphorus contents in the synthetic crystals were determined by CE Instruments Flash 1112 Series EA CHNS-O Analyser.

2.4.3 X-ray Fluorescence Spectrometry

Cu, S, P and halides (Cl, Br and I) qualitative analyses of [Cu(ptu)(PPh₃)₂Cl], [Cu(ptu)(PPh₃)₂Br] and [Cu(ptu)(PPh₃)₂I] were performed by X-ray Fluorescence spectrometer (Perkin Elmer, PW2400).

2.4.4 Fourier Transform Infrared Spectroscopy (FT-IR)

Infrared spectra in the region 4000-400 cm⁻¹ were measured on a Perkin-Elmer 783 Infrared Spectrophotometer and Perkin-Elmer Spectrum GX FTIR-spectrophotometer using potassium bromide disc.

2.4.5 Fourier Transform NMR Spectroscopy (FT-NMR)

¹H and ¹³C –NMR spectra were recorded in DMSO-*d*₃ on a Varian Inova spectrometer at 500 MHz. The chemical shift values are on δ scale and the coupling constants (*J*) are in Hz.

2.5 Crystal Structure Determination

The X-ray diffraction data of [Cu(ptu)(PPh₃)₂Br] and [Cu(ptu)(PPh₃)₂Cl] were collected using SMART APEX CCD at Prince of Songkla University and the data of [Cu(ptu)(PPh₃)₂I] was collected using Bruker APEX CCD at the University of Bristol, England.

The structure of the synthesized crystals were determined by following steps in Figure 23. (Tanchatchawal, 2004)

Figure 23 shows an outline of crystal structure determination in a simplified form as a schematic flowchart. The involved steps are in the boxes. To the right of each is listed the information obtained and to the left an indication of the time-scale involved in carrying out the operation.

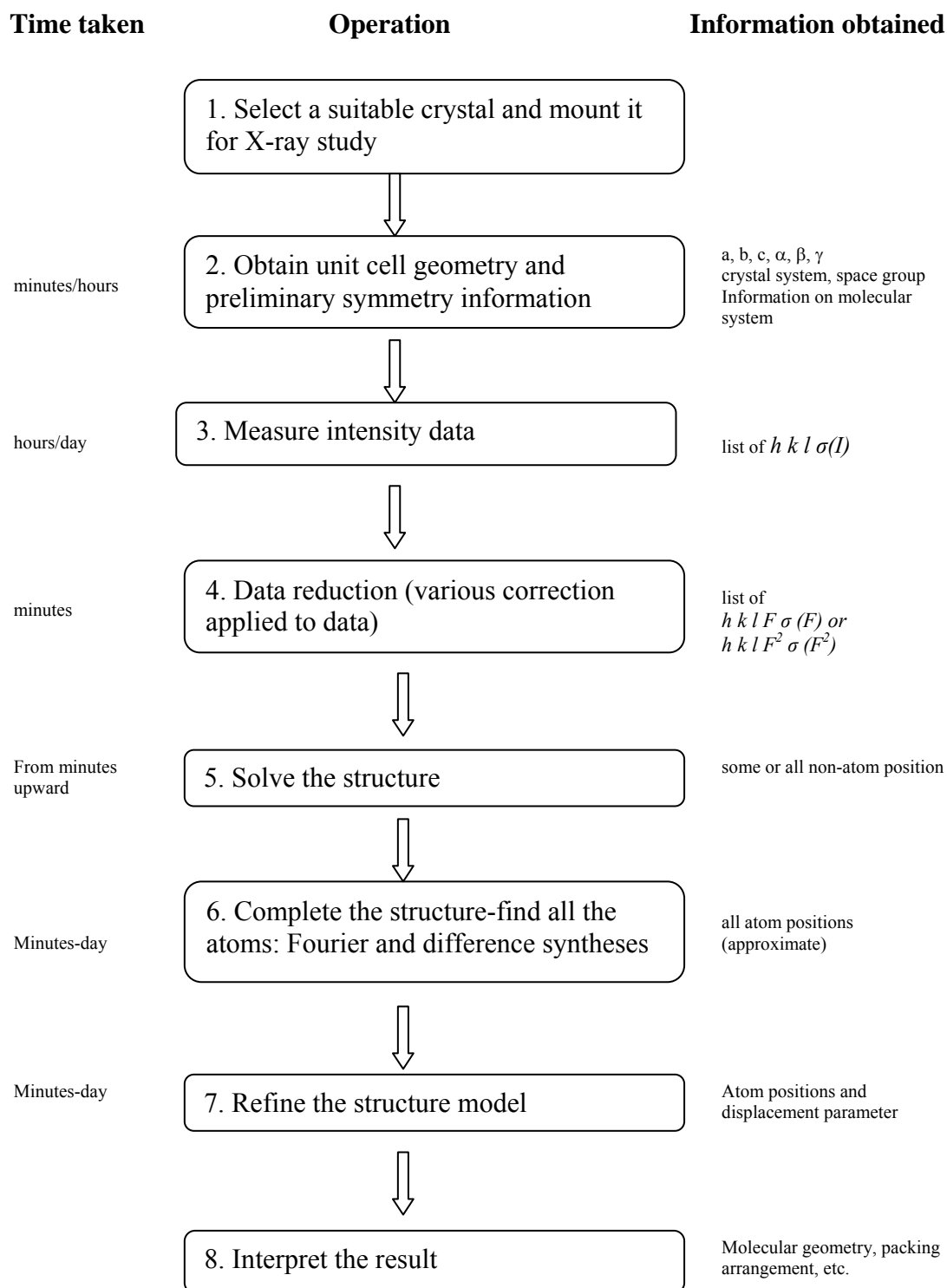

Figure 23 A flowchart for the step involved in a crystal structure determination (Tanchatchawal, 2004).

2.5.1 Selection of a Suitable Crystal

If a crystal is satisfactory for collecting X-ray diffraction data, the following characterizations must be required :

(1) A crystal must be pure at the molecular, ionic or atomic levels. It must be a single crystal. It should not be grossly fractured, bent or otherwise physically distorted.

(2) It must be of proper size and shape, 0.2 – 0.4 mm

(3) Check crystals under a polarizing microscope. A good single crystal will extinguish completely on a distinct position on the crossed polarization filters.

(4) Scan crystal with the Apex CCD, i.e. make a few quick exposures and check the images visually on spot shape, spacing and distribution.

2.5.2 Crystals Mounting

For single-crystal diffractometry it is convenient to have the crystal mounted so that it can be moved for proper alignment and centering in the camera. Crystals need to be mounted in such a way that they can be manipulated in various devices used for intensity measurement. Two methods are commonly used to mount crystals :

(1) Crystals that are not volatile or sensitive to the environment are glued onto a thin glass fiber with an epoxy glue (Figure 24a). All studied crystals were mounted by this method.

(2) Crystals that are air-sensitive or that degrade by loss of loosely bound solvent require special treatment. They may be sealed in thin-walled glass capillary tubes (Figure 24b). Alternatively, the crystals can be coated with an inert viscous oil and then manipulated without difficulty under a normal microscope in the open atmosphere.

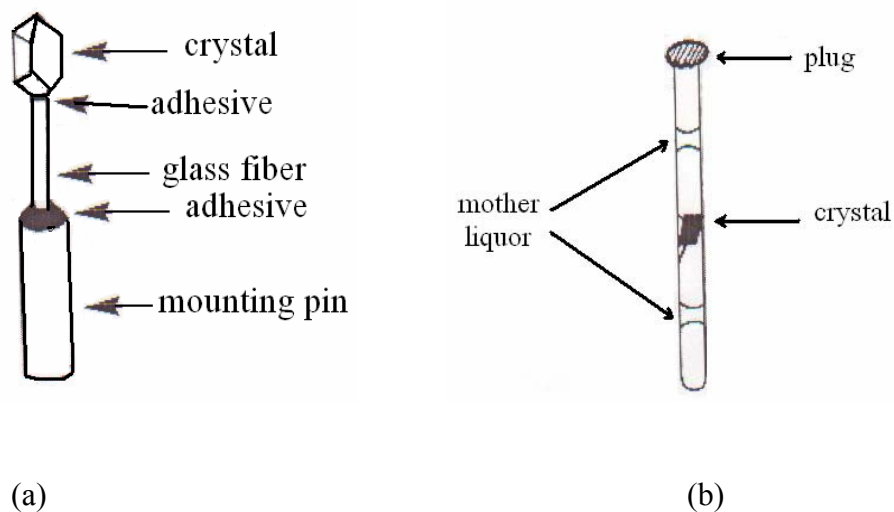

Figure 24 Crystal mounting.

2.5.3 Optical Alignment

The mounted crystal was attached to a goniometer head (Figure 25). The goniometer head is a delicate instrument that can be translationally adjusted (in 3 dimensions) to bring the crystal into the X-ray beam and center it on an axis of rotation (ω) defined by the goniometer. The goniometer rotates ω slowly during data collection to bring different reflections into diffraction position. It is absolutely critical that the translation screws on the goniometer head be adjusted so that the crystal is centered in the X-ray beam throughout 360 degrees of rotation in ω .

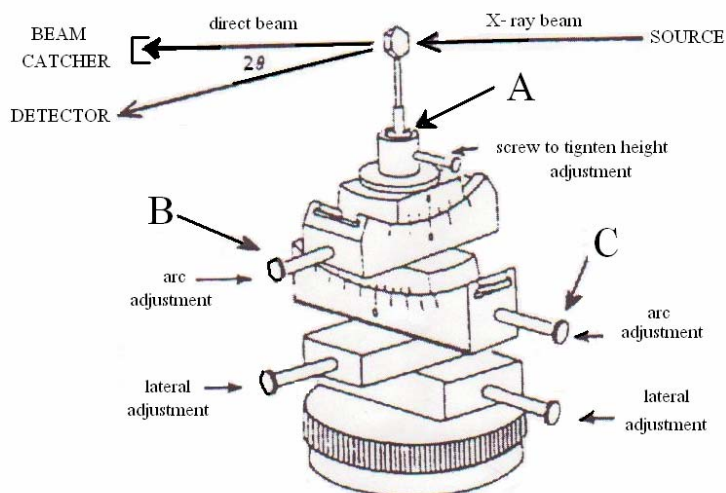

Figure 25 The goniometer head.

2.5.4 Data Collection

The goal of data collection is to determine the indices and record the intensities of as many reflections as possible, as rapidly and efficiently as possible. For this work, the device used for data collection is the SMART APEX CCD area detector with the Bruker platform diffractometer at Prince of Songkla University Crystallography Lab.

2.6 X-ray Diffractometry

The SMART APEX system (Figure 26) consists of the following basic components.

- 3-axis goniometer module with SMART APEX detector
- Radiation safety enclosure with interlocks and warning lights
- D8 controller
- Refrigerated recirculator for SMART APEX detector
- Computer

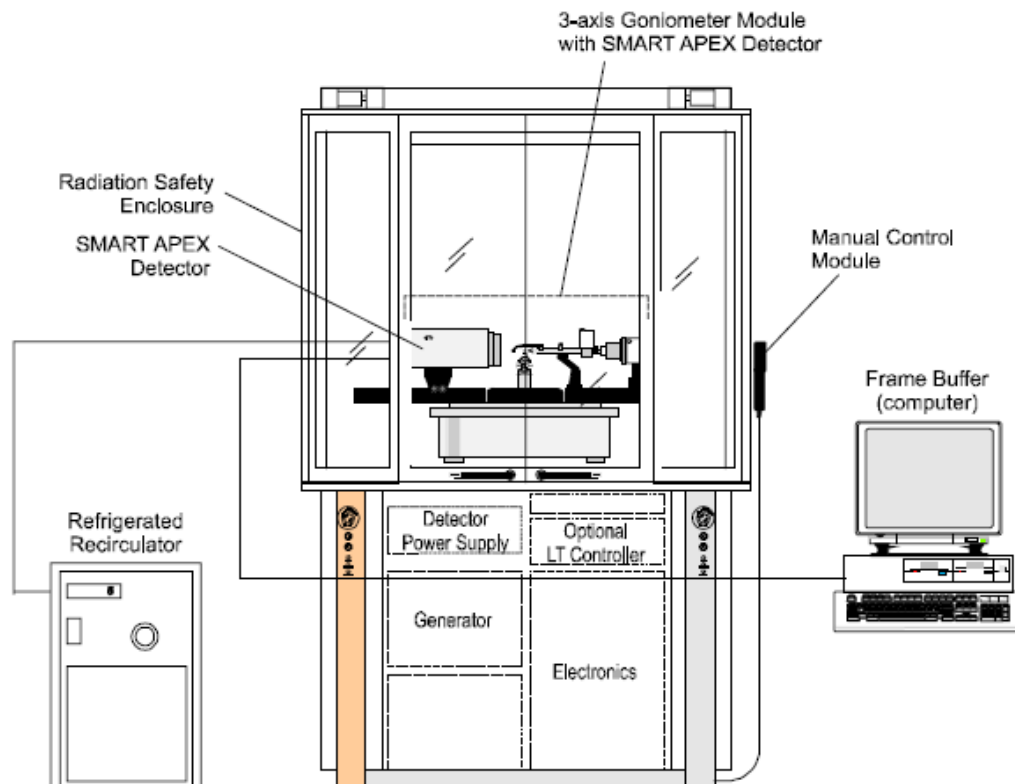

Figure 26 SMART APEX system components.

3-Axis Goniometer Module with SMART APEX Detector

The 3-axis goniometer module and its associated SMART APEX detector comprise the unique hardware of the SMART APEX system. This is the part of the instrument that actually performs the experiment. Several components comprise the 3-axis goniometer module with SMART APEX detector (Figure 27).

- Goniometer with fixed chi (χ) stage
- X-ray source (including shielded X-ray tube, X-ray safety shutter, and graphite crystal monochromator)
- SMART rotary shutter and incident beam collimator (with beam stop)
- SMART APEX detector
- K760 X-ray generator
- Manual control module
- Video camera

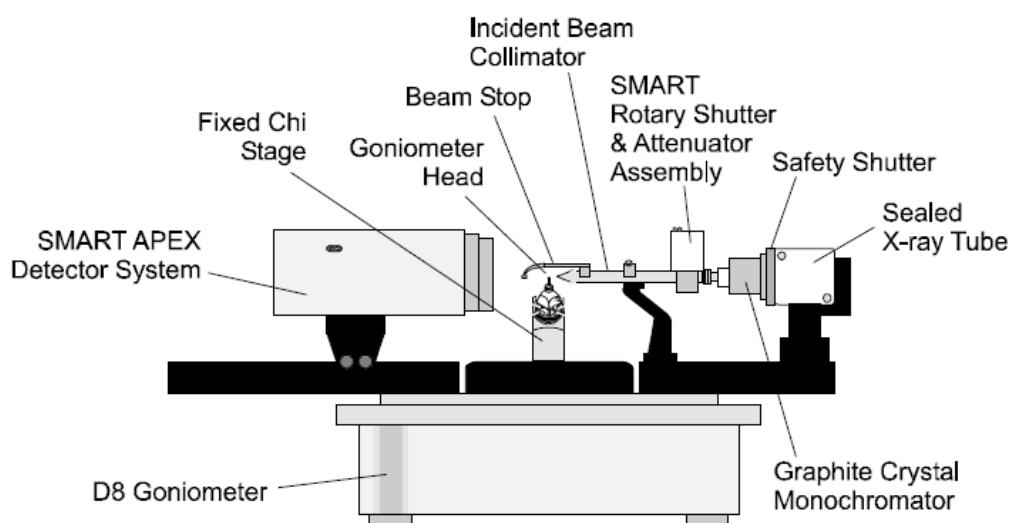

Figure 27 SMART APEX & goniometer module instrumentation.

Goniometer with Fixed Chi Stage

The standard SMART APEX system uses a horizontally oriented D8 PLATFORM goniometer base (with 2-theta [2θ] and omega [ω] drives) with dovetail tracks for the X-ray source and the detector, and mounting posts for accessories such as the video camera and optional low temperature attachment. The goniometer is mounted on an ω -circle, lying, in the horizontal plane, and so having a vertical rotation axis. The goniometer make a fixed chi angle (χ) of approximately 54.74° with the vertical rotation axis and a phi drive with 360° (ϕ) rotation. All four axes (2θ , ϕ , χ , and ω) intersect within a volume of approximately 10 microns. These axes are shown in Figure 28.

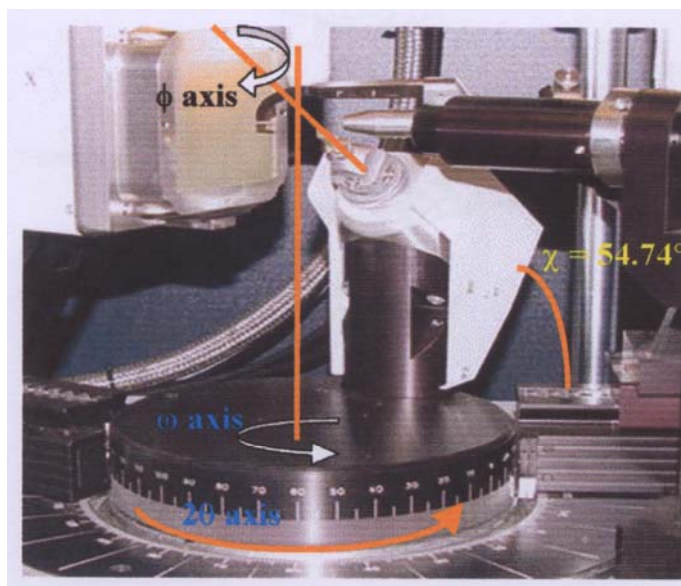

Figure 28 Fixed χ , 3-axis goniometer.

X-ray Source

Three components (Figure 27) comprise the X-ray source: a shielded X-ray tube, an X-ray safety shutter, and a graphite crystal monochromator. The sealed tube X-ray source, with a molybdenum (Mo) target, produces the X-ray beam used by the SMART APEX system. The X-ray safety shutter is built into the X-ray tube shield. The shutter opens upon initiation of a set of exposures and closes upon the end of collection. Status lamps on the shutter housing indicate when the shutter is open (red) and closed (green). The shutter is also interfaced to the controller and to the safety interlocks. A tunable graphite crystal monochromator selects only the K_{α} line ($\lambda = 0.71073\text{\AA}$) emitted from the Mo X-ray source and passes it down the collimator system.

SMART APEX Detector

-The SMART APEX detector is specific to this system. It is mounted on a 2θ dovetail track.

-The track has a scale that is calibrated to indicate the distance from the crystal to the phosphor window (a distance is 5 cm). Status lamps on the detector housing indicate when the detector is on (green) and off (red).

K760 X-ray Generator

The K760 X-ray generator is a high-frequency, solid-state X-ray generator, which provides a stable source of power for operations up to 60 kilovolts (kV) and 50 milliamps (mA). For the SMART APEX system, power settings should never exceed the maximum power rating of the X-ray tube (Typical maximum power settings for the SMART APEX system with a normal focus tube are 50 kV, 30 mA. The kV setting should not exceed 50 kV). This generator is interfaced to the controller, and the power settings may be adjusted either from front panel buttons or from within the SMART software.

Video Camera

The video camera, an essential part of the system, allows to visualize the crystal to optically align it in the X-ray beam and to measure the crystal dimensions and index crystal faces. The camera is interfaced to the computer and is operated through the VIDEO program. The camera is mounted in the accessories track of the goniometer base.

Refrigerated recirculator for SMART APEX detector

The refrigerated recirculator uses Peltier technology to cool the CCD chip to a required -40°C to minimize dark currents.

Computer

Included with the system is a high-speed computer, which is used for control of the experiment, storage of raw frame data, integration of data, and solution and refinement of the structure. The computer uses the Microsoft Windows NT® operating system and includes the software.

2.7 Structure Determination and Refinement

The integration process (SAINT) has produced two important files—`compid.p4p`, containing the final unit cell parameters and other important information on how the experiment was carried out, and `compid.raw`, containing the actual intensity data where `compid` is the compound identification code. These files are all

that is required to begin the structure solution and refinement process. The various steps in solving and refining the structure are carried out using the programs of the SHELXTL package (Sheldrick, *et al.*, 1997).

A simplified flow chart is shown in Figure 29.

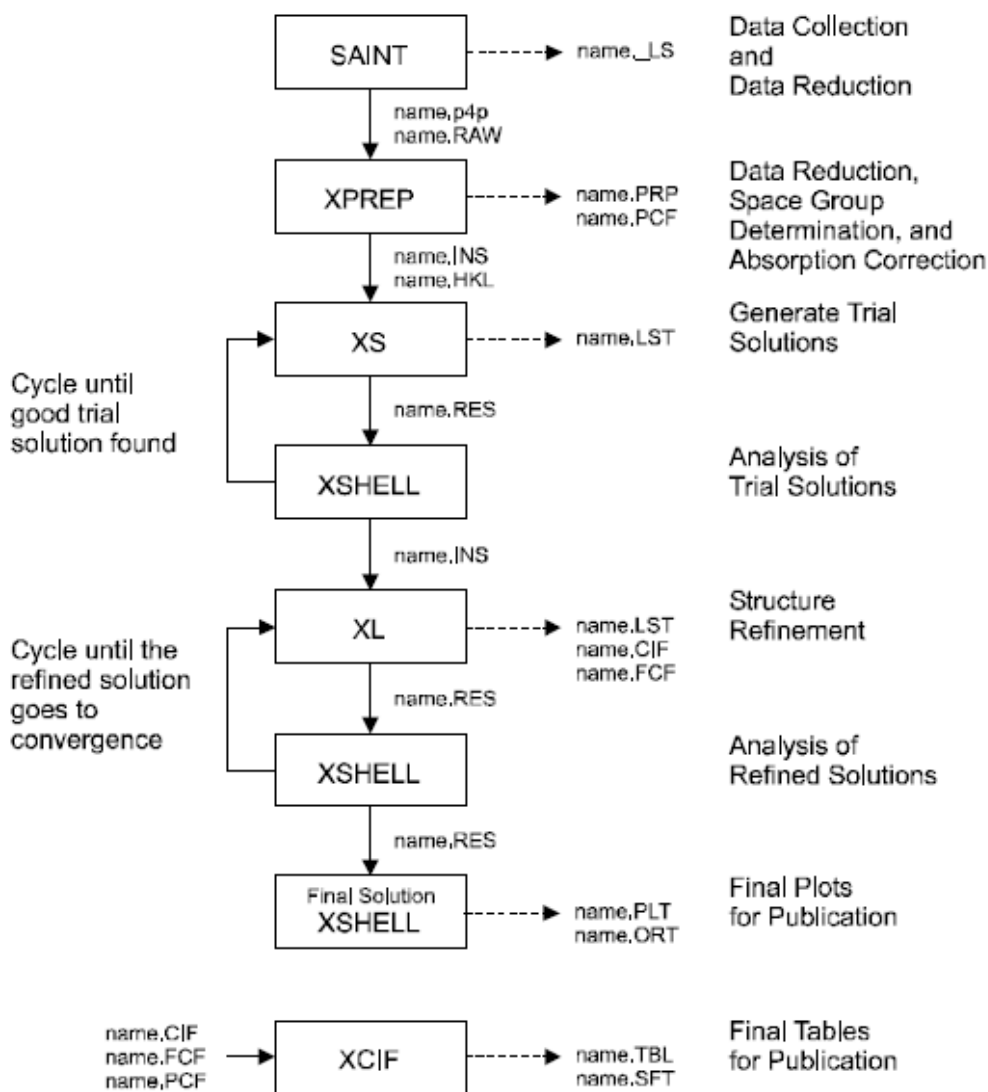

Figure 29 A flowchart of structure determination and refinement.

2.7.1 Obtaining Unit Cell Geometry and Symmetry

Some reflections of moderate to high intensity are located by simply driving the various motor while monitoring the detector output for a single significantly above background (a blind search, all under computer control). From these positions, the

crystal orientation, unit cell geometry and reflection indices have to be determined simultaneously, by calculations which are not simple and are usually regarded as computer black-box methods, but they are all based essentially on the Bragg equation (Appendix A). A diffractometer will often give a unit cell and orientation for a crystal in less than an hour ; a few minutes are usually enough with an area detector.

2.7.2 The measurement of intensities

The diffractometer with CCD detector measures intensities of diffracted beams in an automatic, computer-controlled process.

The result of this process is a list of reflections, usually thousands of them, each with hkl indices and measured intensity. In addition, from diffractometer measurements each intensity I has an associated standard uncertainty (s.u.), $\sigma(I)$, which is calculated from the known statistical properties of the X-ray generation and diffraction processes, and is a measure of the precision or reliability of the measurement.

2.7.3 Data Reduction

The intensity of an X-ray beam is proportional to the square of the wave amplitude [$I(hkl) \propto |F(hkl)|^2$]. The measured intensity is affected by various factors, eg. Lorenz-polarization factors, absorption problems etc., however, for which corrections must be applied. The conversion of intensities I to ‘observed structure amplitudes’ $|F_o|$ (o = observed) or F_o^2 and, correspondingly, of s.u.’s $\sigma(I)$ to $\sigma(F_o)$ or $\sigma(F_o^2)$ is known as data reduction and has several components.

The various corrections for the intensities are applied also to their s.u.’s. The result of this whole process, which usually takes only a matter of minutes on a computer, is a list of reflection as $h, k, l, |F_o|, \sigma(F_o)$ [or $h, k, l, F_o^2, \sigma(F_o^2)$]; the advantage of retaining the squared form is that no special treatment is required for intensities measured as negative.

Structure Determination and Refinement by Xtal Program Version 3.6

Most Xtal calculations (Hall, *et al.*, 1999) are controlled, from a input file usually known as the .dat file. The results of a calculation are output to files and a screen device (as in graphics applications). Xtal calculations use various files to store intermediate and archival data. This strong dependence on files means that Xtal is considered a file-driven archival system, rather than an interactive menu-driven system.

The convention for filename construction for all Xtal files is normally compid.ext, where compid is the compound identification code (maximum of six characters), and ext is the extension code (three characters). The compid code is defined by the user at the start of the input commands with the line "compid". The followings are step by step of solving the structure.

(1) Getting started

This step is making binary data files, that are used extensively as working files (ie. intermediate files for exchanging within, and between, calculations), and to archive certain types of data. The used subprograms are

STARTX	:	Create initial archive file
DIFDAT	:	Process diffractometer data
SORTRF	:	Sort and merge reflection data
ADDREF	:	Add reflection data

(2) Solving the structure

There are 2 methods, that were used to solve the structures :

(a) Heavy atom methods

The methods involve solving structure of compounds that have heavy atoms. The used subprograms are

GENEV	:	Normalized structure factors (E values)
FOURR VECT	:	Patterson Fourier map
PEKPIK	:	Search for peaks in map

(b) Direct methods

The methods involve solving structure of compounds that have no heavy atoms. The subprograms are

GENEV

GENSIN	:	Generate triplets and quartets
GENTAN (or SIMPEL)	:	Tangent phasing
FOURR EMAP		
PEKPIK		
CRISP	:	Crystal iterative solution program

GENSIN, GENTAN and FOURR EMAP can be replaced by CRISP.

(3) Refining the structure

Once all atoms have been found, the model structure needs to be refined. This means varying the numerical parameters describing the structure to produce the best agreement. Anisotropic thermal parameters are used for all non-hydrogen atoms. Hydrogen atoms were located in difference Fourier analyses and included with coordinations refined.

The refinement process uses a well-established mathematical procedure called least-squares analysis, which define the best fit two sets of data (here $|F_o|$ and $|F_c|$) to be that which minimizes one of the least-squares sums : $\sum w(|F_o| - |F_c|)^2$

w	=	Reflection weights
F_o	=	Observed structure factors
F_c	=	Calculated structure factors

The used subprograms are

ADDDATM	=	Load atom parameters
CRYLSQ	=	Structure factor least-squares refinement

(4) Checking geometry

This step is checking the structure. If atoms of the model structure are approximately in the right positions, there should be at least some degree of resemblance between the sets of calculated structure factors, $|F_c|$, and observed structure factors, $|F_o|$. This is the most widely used assessment is a so-called residual factor or *R*-factor, define as

$$R = \frac{\sum ||F_o| - |F_c||}{\sum |F_o|}$$

$$\text{XTAL, } R_w = \sqrt{\frac{\sum w(|F_o| - |F_c|)^2}{\sum w(F_o)^2}}$$

$$\text{SHELXTL, } wR2 = \sqrt{\frac{\sum w(F_o^2 - F_c^2)^2}{\sum w(F_o^2)^2}}$$

For a correct and complete crystal structure determination from well measured data, R is typically around 0.02-0.05 or 2-5 % . Values of R_w based on F^2 are generally higher than those base on F values. The used subprograms are:

CRYLSQ

BONDLA : Bond lengths and angles

(5) Preparing for publication

This step is showing the result by pictures and numerical parameters for report and publishing. The used subprograms are:

LISTFC : List formatted reflection data

LSQPL : Least-squares planes & lines

ORTER : Molecular plot

PLOTX : Interface plot devices

ATABLE : Tabulate atomic parameters

CHAPTER 3

Results

3.1 The studies for preparation of complexes

The copper(I) halide complexes with mixed triphenylphosphine and phenylthiourea ligands were prepared in optimum condition. The X-ray crystal structures of these complexes (details of crystal and structure refinement are shown in Table 1) have been determined. Some of their physical properties and with reacting ligands are summarized in Table 3.

Table 2 Preparation conditions of complexes.

Reactants	Mole ratio	Solvent	Temp* (°C)	Complexes
CuCl:PPh ₃ :ptu	1 : 1 : 3	ethanol : ethyl acetate	70-75	[CuCl(PPh ₃) ₂ (ptu)]
CuBr:PPh ₃ :ptu	1 : 1.5 : 2.5	ethanol : acetonitrile	70-75	[CuBr(PPh ₃) ₂ (ptu)]
CuI:PPh ₃ :ptu	1 : 2 : 3	acetonitrile	70-75	[CuI(PPh ₃) ₂ (ptu)]

*Temp = temperature

Table 3 The physical properties of ligands and complexes.

Compound	Physical properties			
	Appearance	Colour	Melting point (°C)	Solubility
Ligand ptu	Powder	White	145-150 ^a	x
Ligand PPh ₃	Powder	White	79-81	xx
[CuCl(PPh ₃) ₂ (ptu)]	Needle	Colourless	196-197	xxx
[CuBr(PPh ₃) ₂ (ptu)]	Needle	Colourless	197-198	xxx
[CuI(PPh ₃) ₂ (ptu)]	Needle	Colourless	184-185	xxx

soluble^x = soluble in ethanol, acetone, acetonitrile

soluble^{xx} = soluble in ethanol, acetone, acetonitrile and water

soluble^{xxx} = soluble in chloroform, dibromomethane, DMSO, acetone and acetonitrile

^aThe Merck index, 1996:80.

3.2 Elemental analysis

Table 4 The partial elemental analyses of the complexes.

Compound	%C Found (Calcd.)	%H Found (Calcd.)	%N Found (Calcd.)	%S Found (Calcd.)
[CuCl(PPh ₃) ₂ (ptu)]	66.43(0.08) 66.56	4.82(0.45) 4.95	3.63(0.03) 3.61	4.27(1.87) 4.13
[CuBr(PPh ₃) ₂ (ptu)]	62.88(0.33) 62.96	4.62(0.49) 4.68	3.71(0.68) 3.42	3.97(1.09) 3.91
[CuI(PPh ₃) ₂ (ptu)]	60.28(0.46) 59.55	4.46(0.08) 4.43	3.56(0.70) 3.23	3.93(1.00) 3.70

3.3 X-ray Fluorescence Spectrometry

The X-ray fluorescence spectrum of the complexes are shown in Figures 30-38.

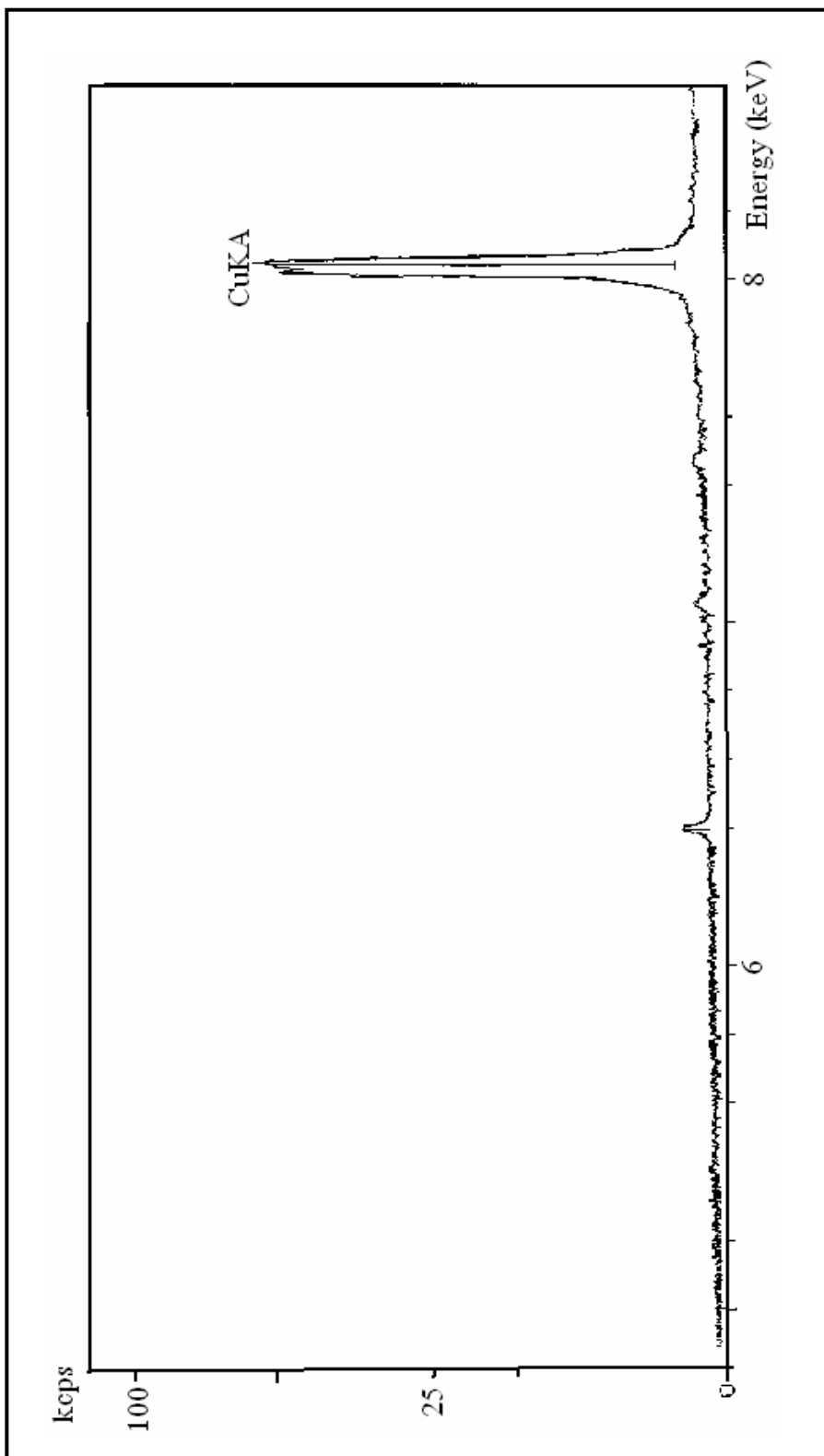

Figure 30 The Cu (K_{α}) spectrum of [CuCl(PPh₃)₂(ptu)].

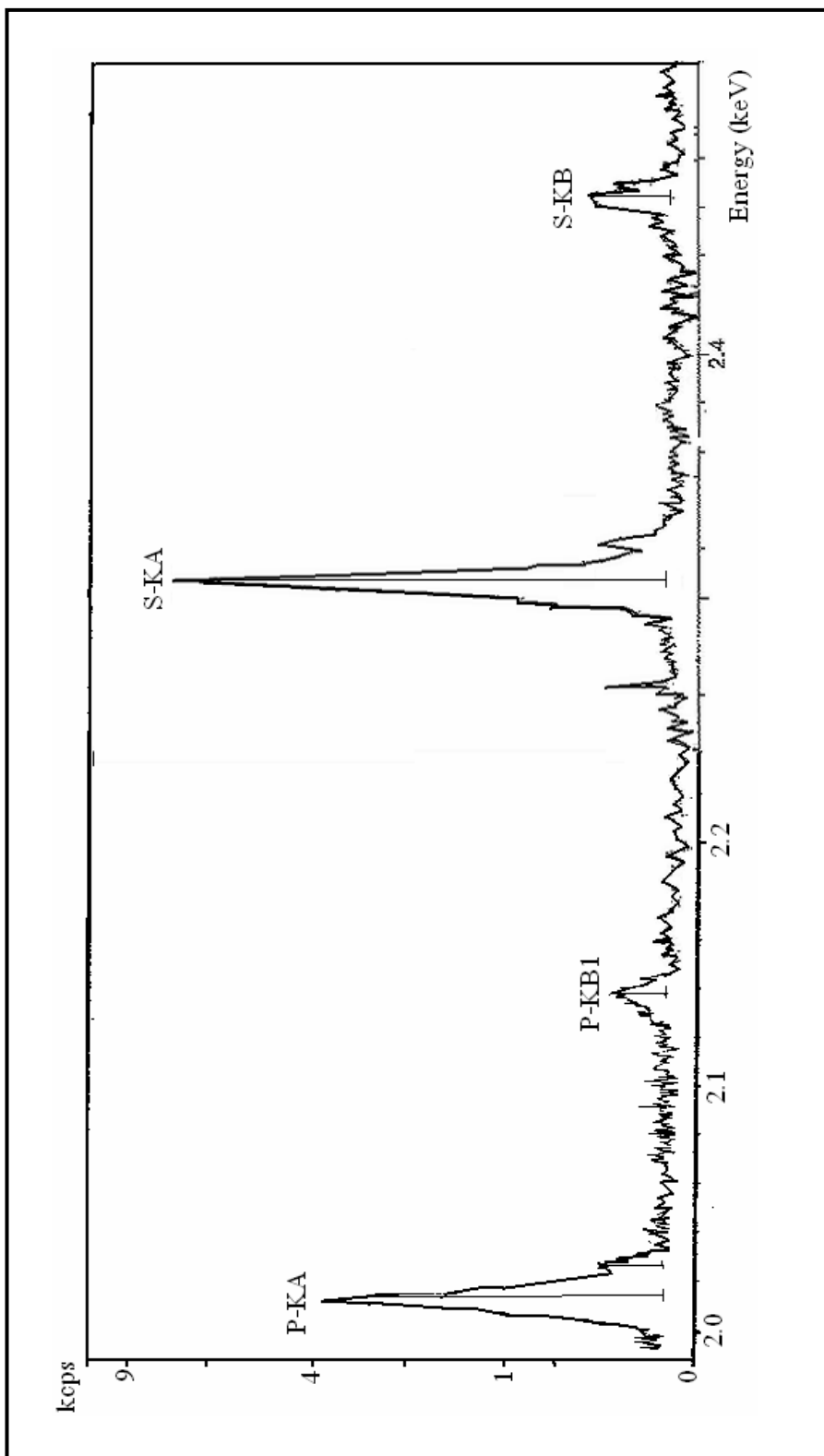

Figure 31 The $\text{S}(K_\alpha)$, $\text{S}(K_\beta)$, $\text{P}(K_\alpha)$ and $\text{P}(K_\beta)$ spectrum of $[\text{CuCl}(\text{PPh}_3)_2(\text{ptu})]$.

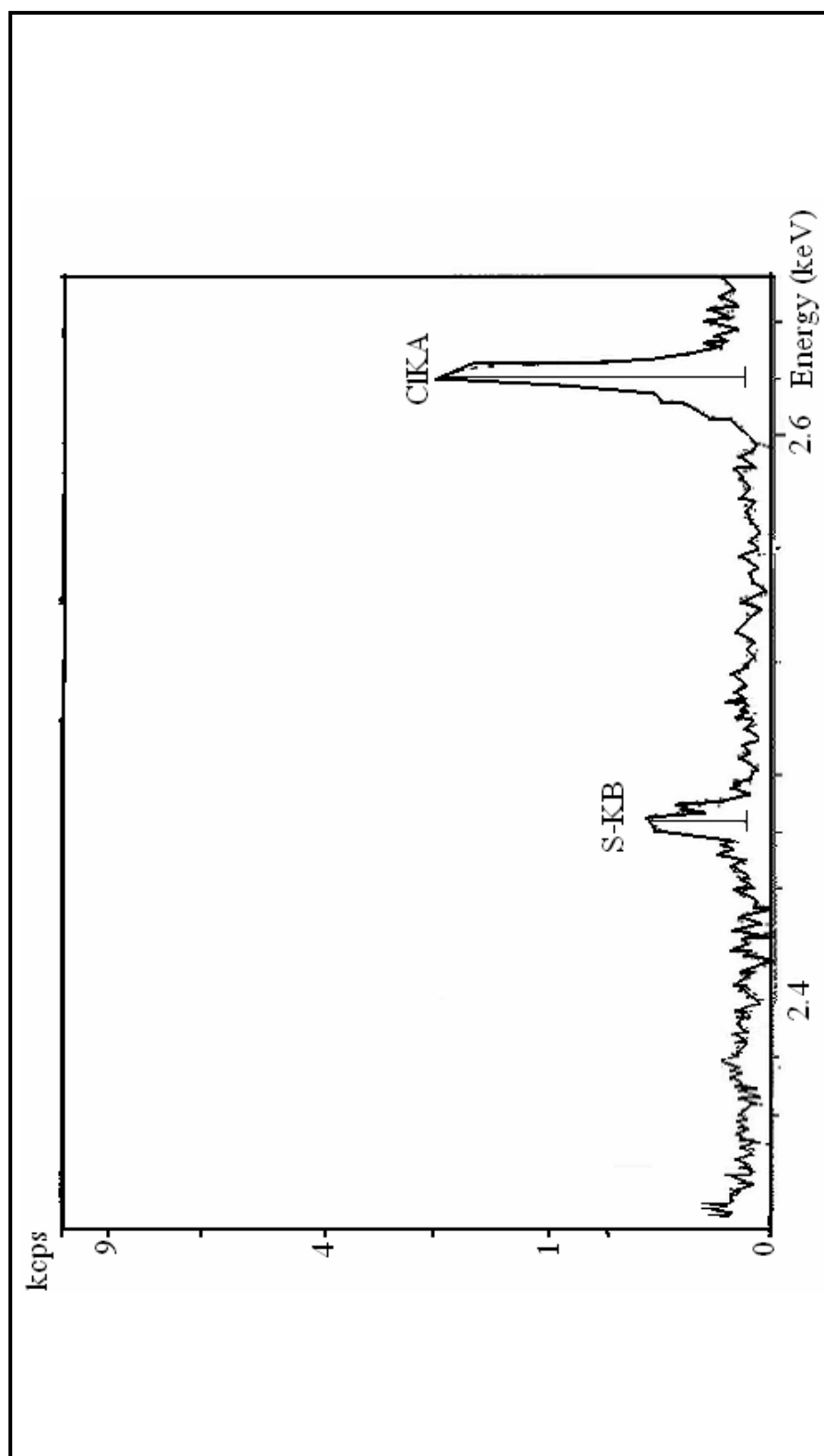

Figure 32 The Cl(K_{α}) spectrum of [CuCl(PPh₃)₂(PTU)].

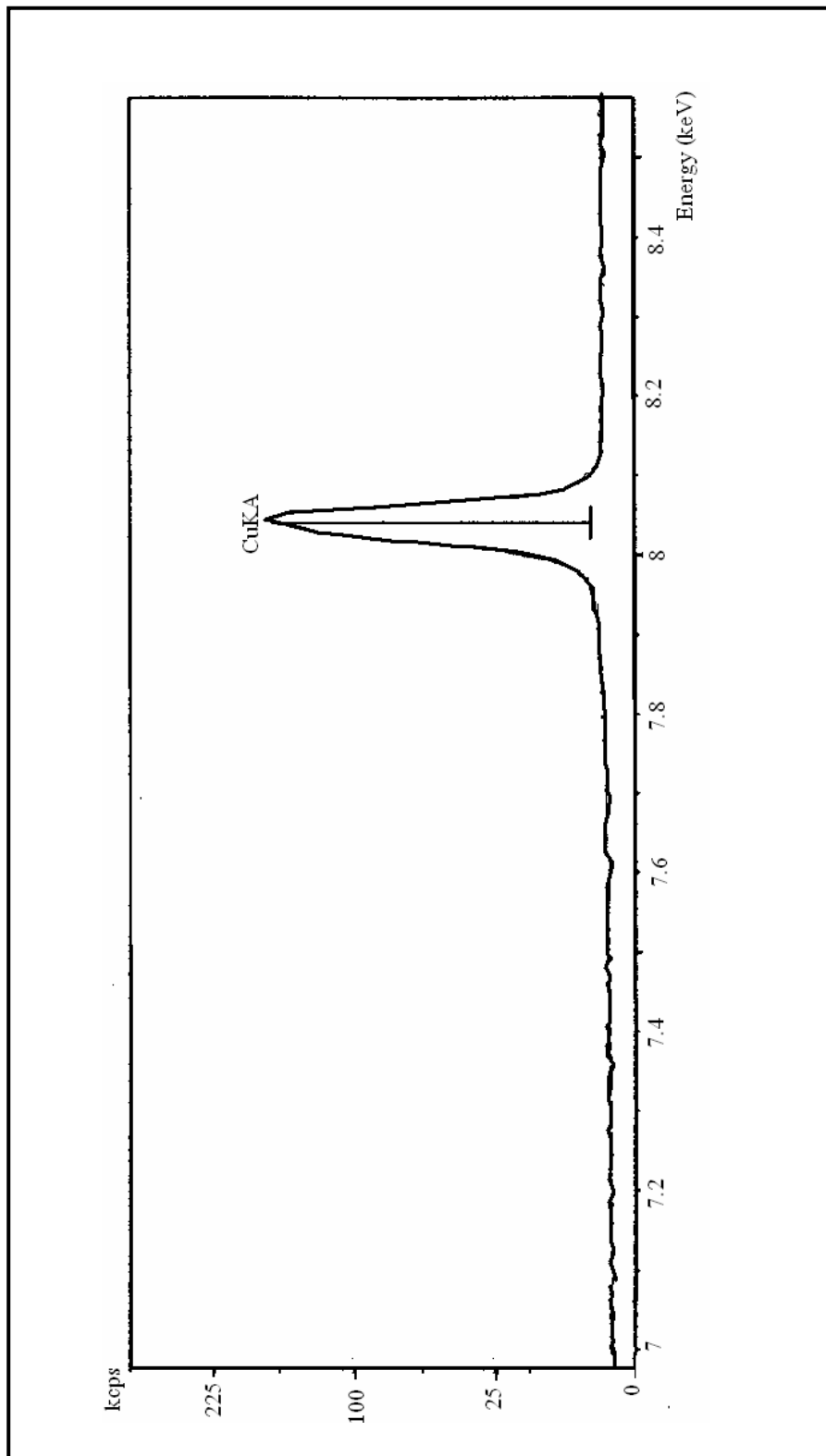

Figure 33 The $\text{Cu}(K\alpha)$ spectrum of $[\text{CuBr}(\text{PPh}_3)_2(\text{PTU})]$.

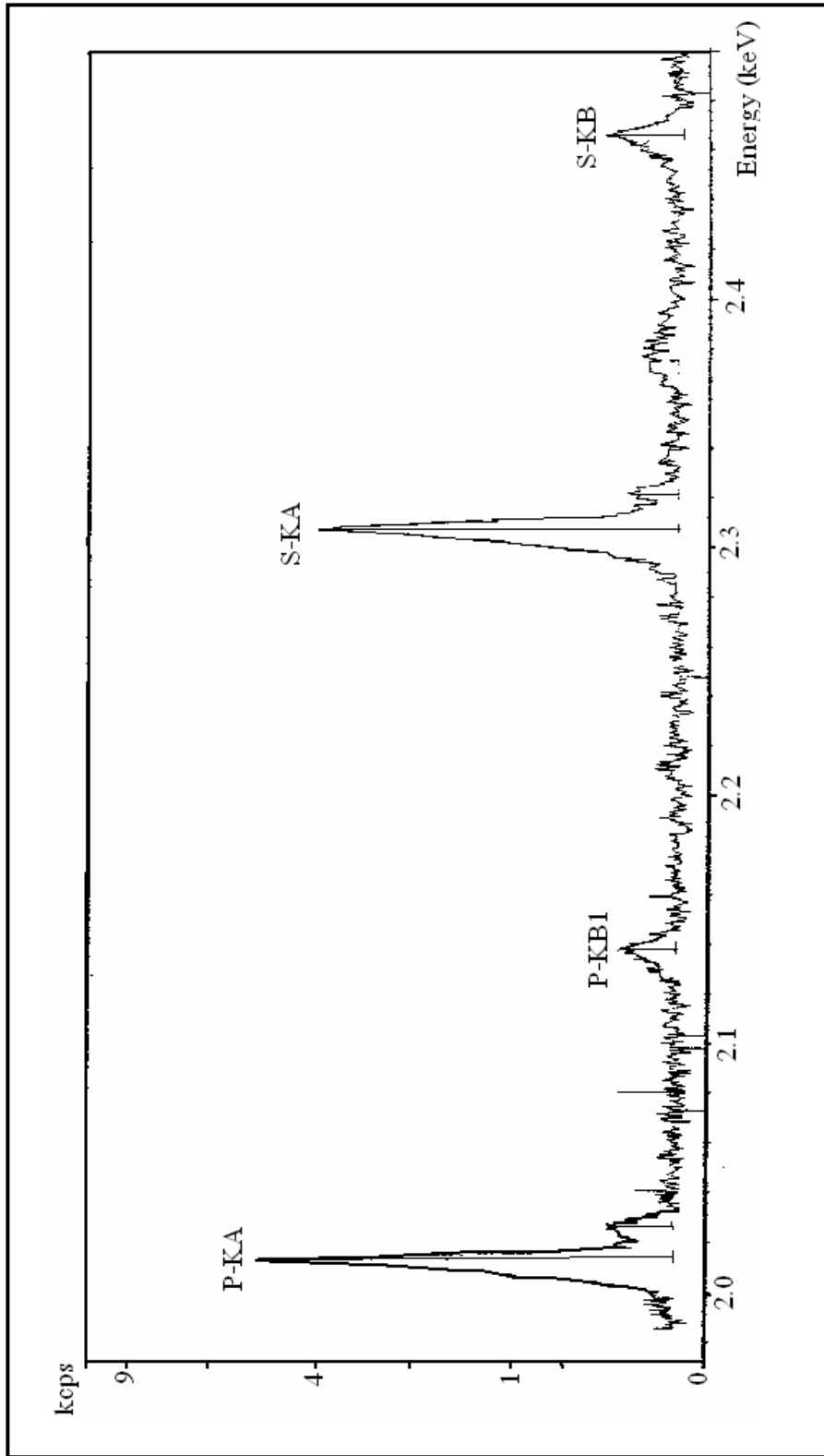

Figure 34 The S(K_{α}), S(K_{β}), P(K_{α}) and P (K_{β}) spectrum of [CuBr(PPh₃)₂(PTU)].

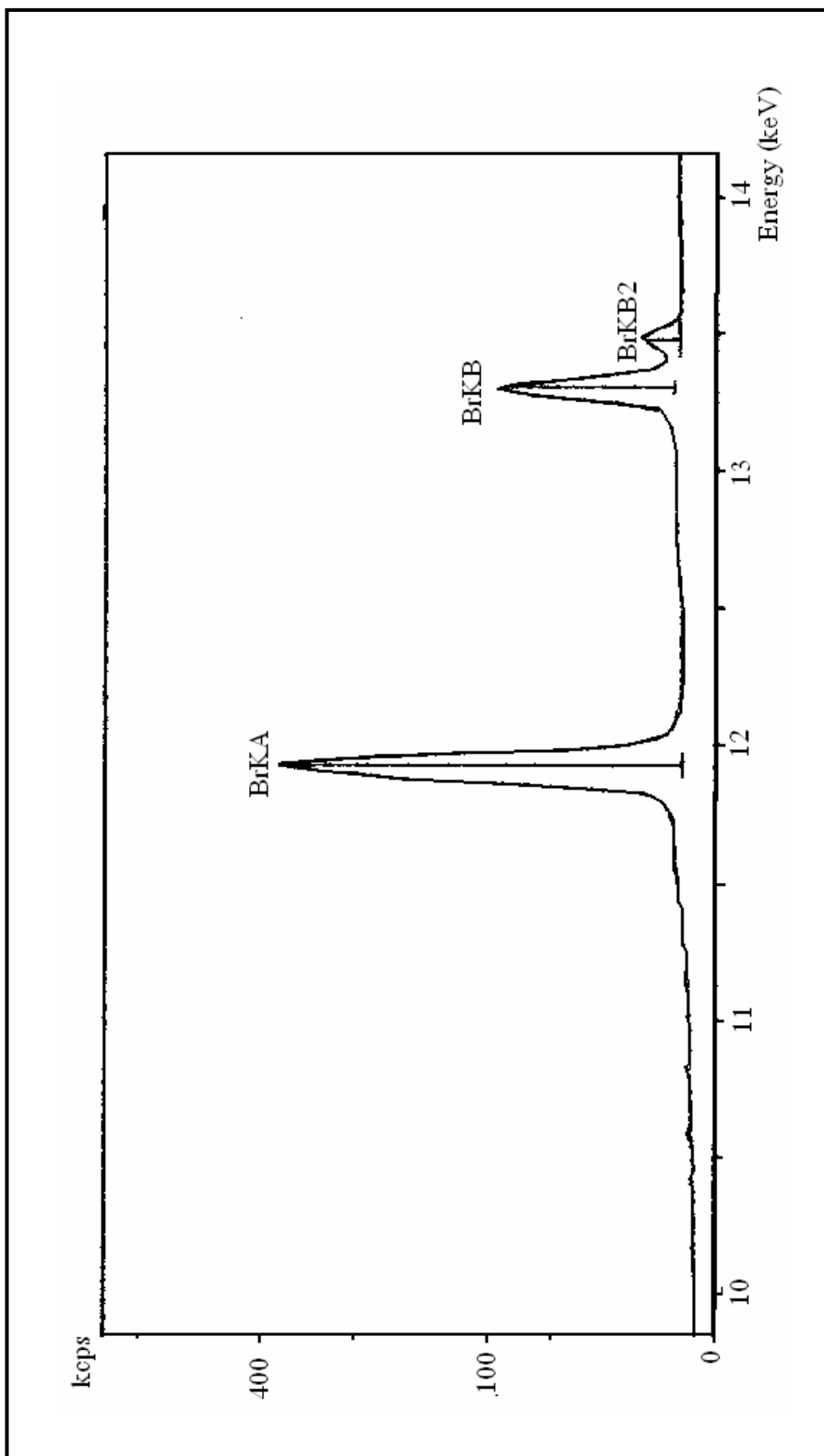

Figure 35 The Br (K_{α}) and Br (K_{β}) spectrum of $[\text{CuBr}(\text{PPh}_3)_2(\text{ptu})]$.

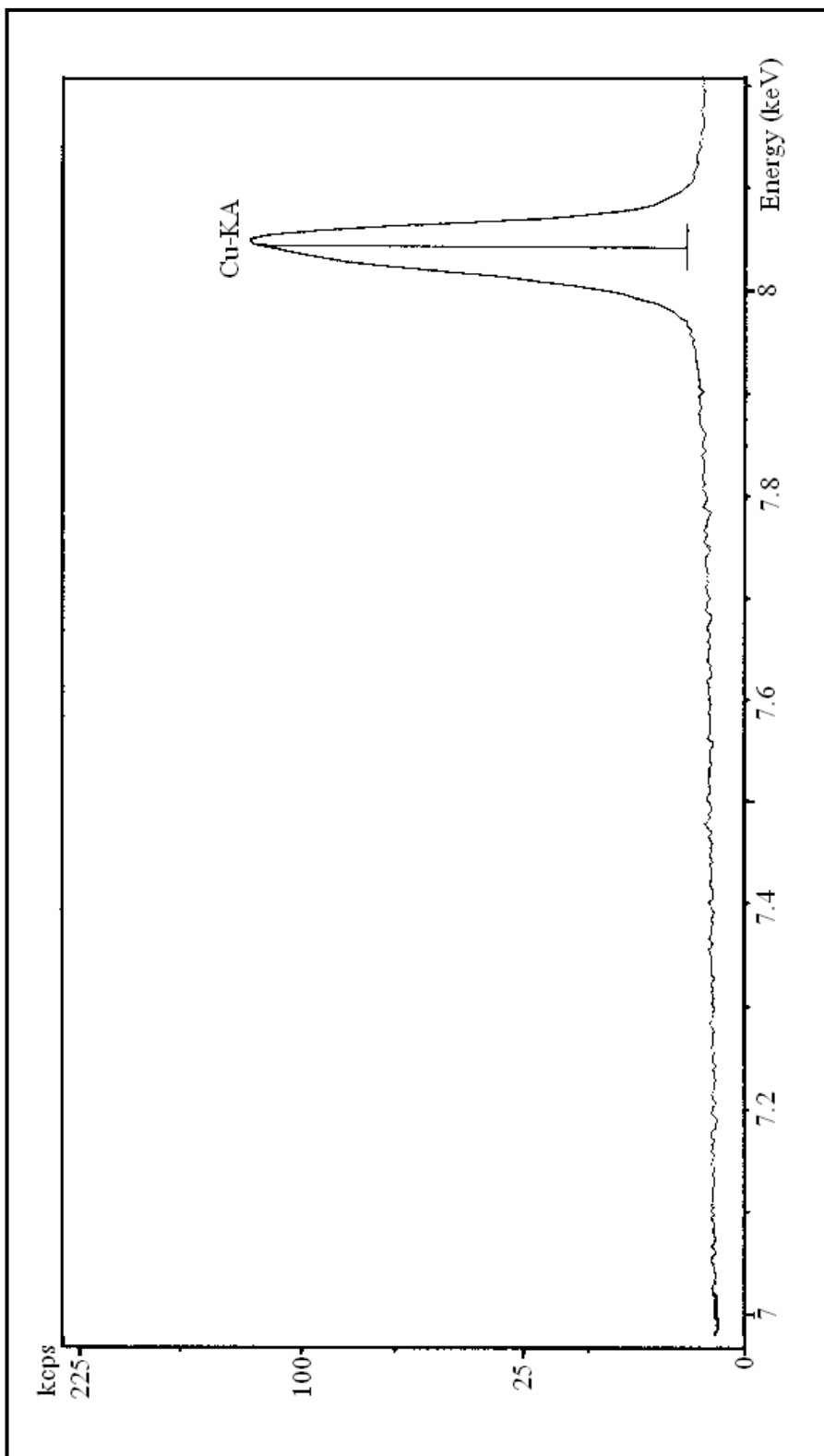

Figure 36 The Cu (K_{α}) spectrum of $[\text{CuI}(\text{PPH}_3)_2]_2(\text{PTU})$.

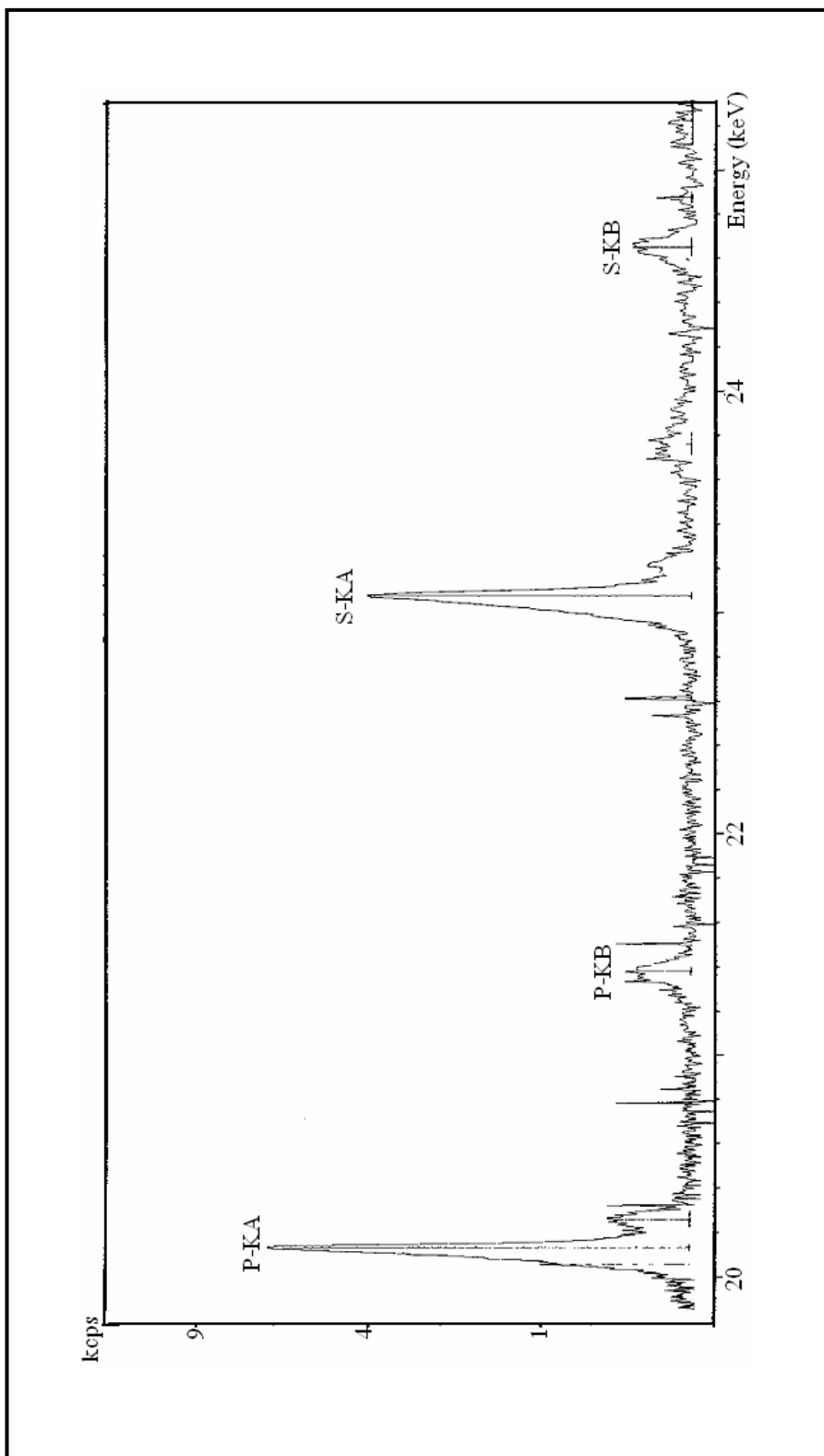

Figure 37 The S (K_{α}), S (K_{β}), P (K_{α}) and P (K_{β}) spectrum of [CuI(PPh₃)₂(PTU)].

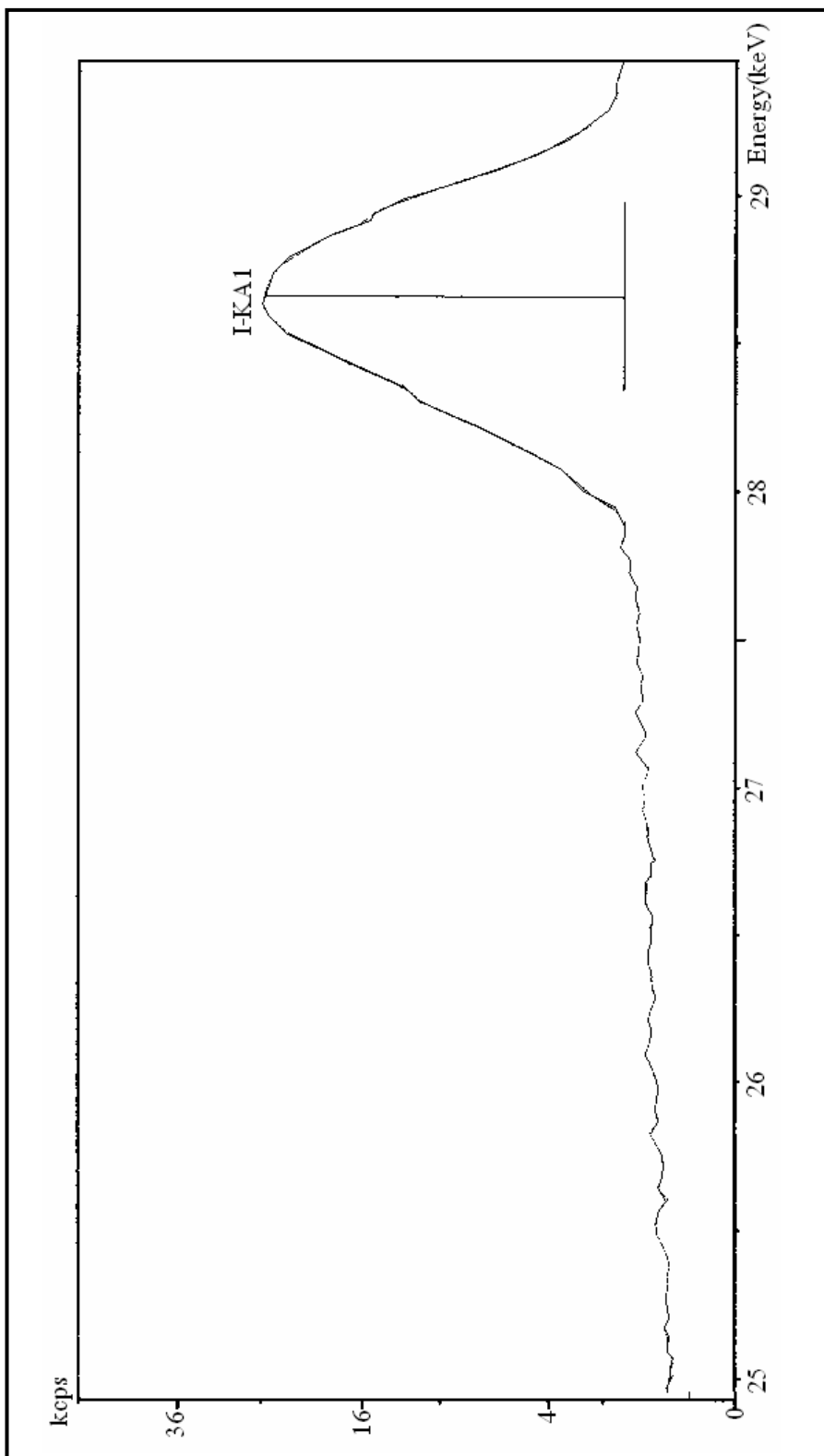

Figure 38 The I (K_{α}) spectrum of [CuI(PPh₃)₂(ptu)].

3.4 Infrared Spectroscopy

The infrared spectrum of the ligands and compounds are shown in Figure 39-43.

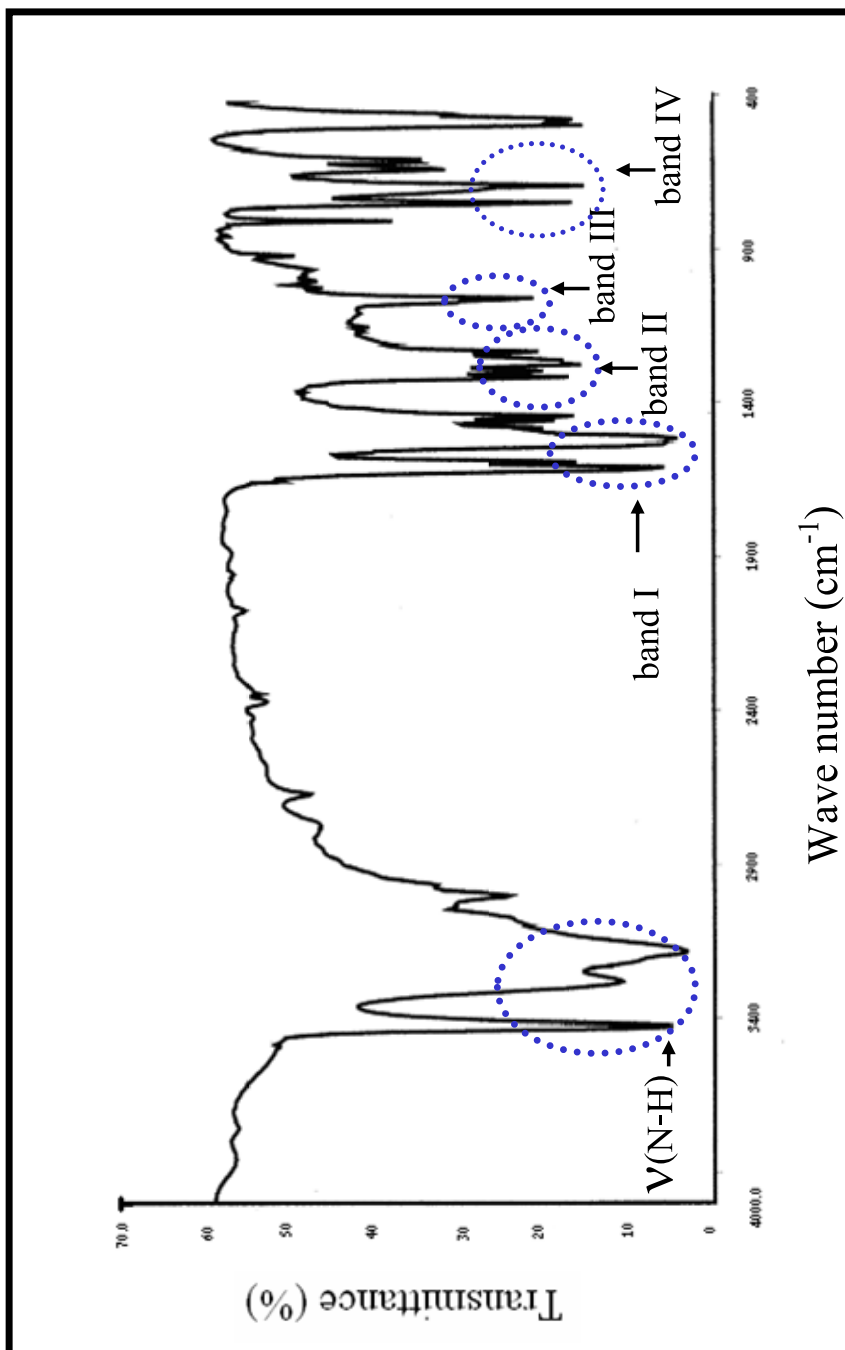

Figure 39 The infrared spectrum of *N*-phenylthiourea(put).

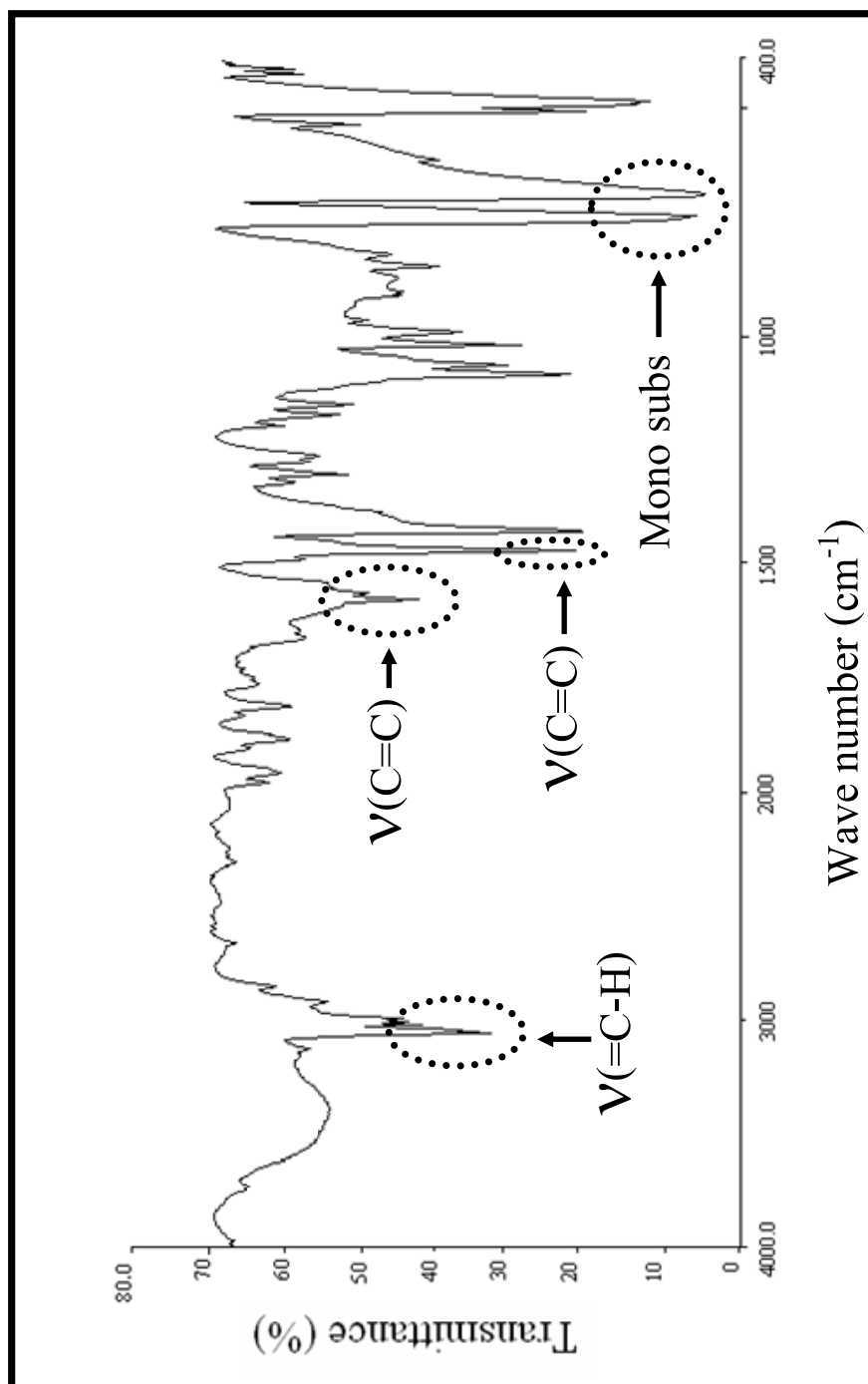
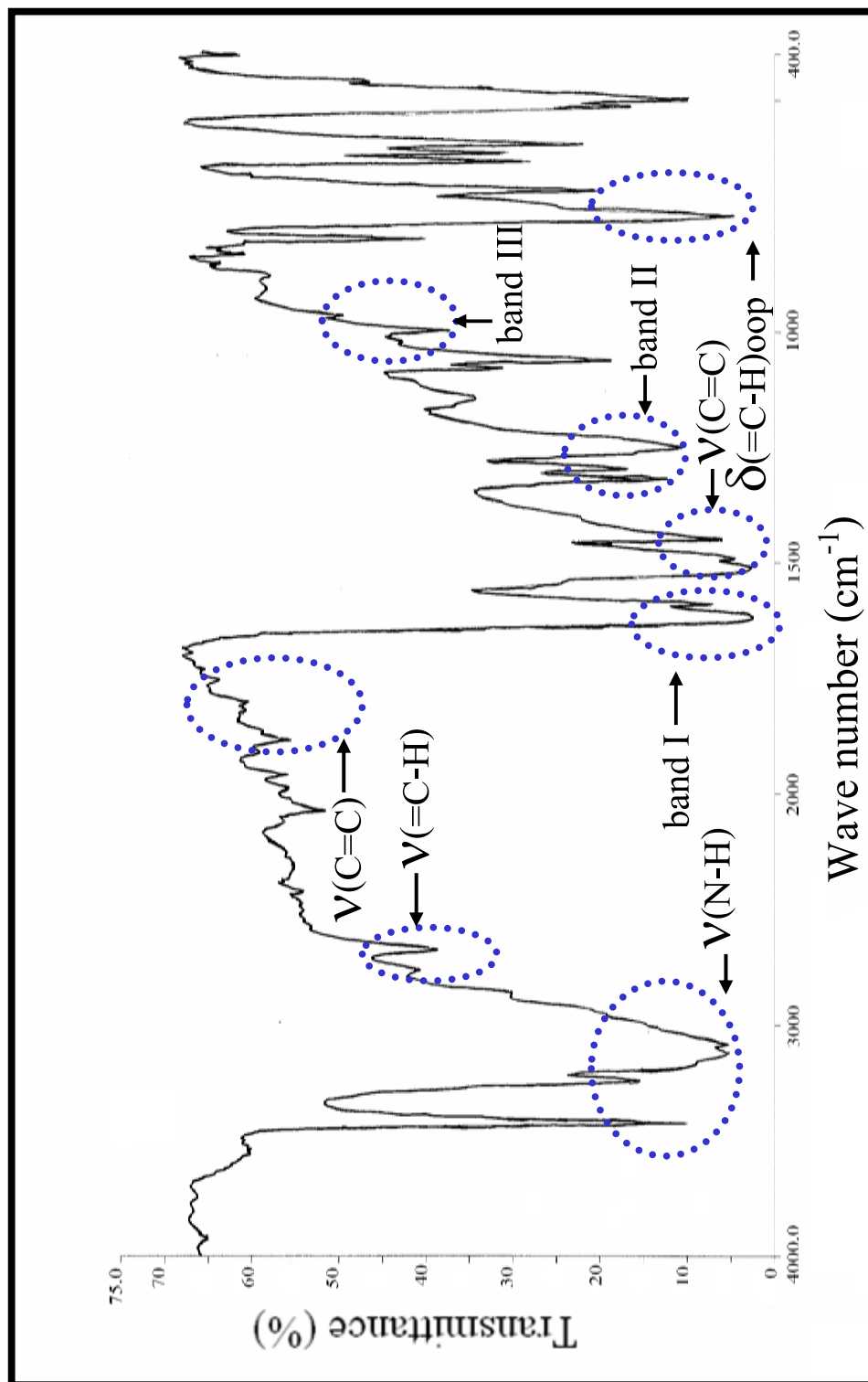
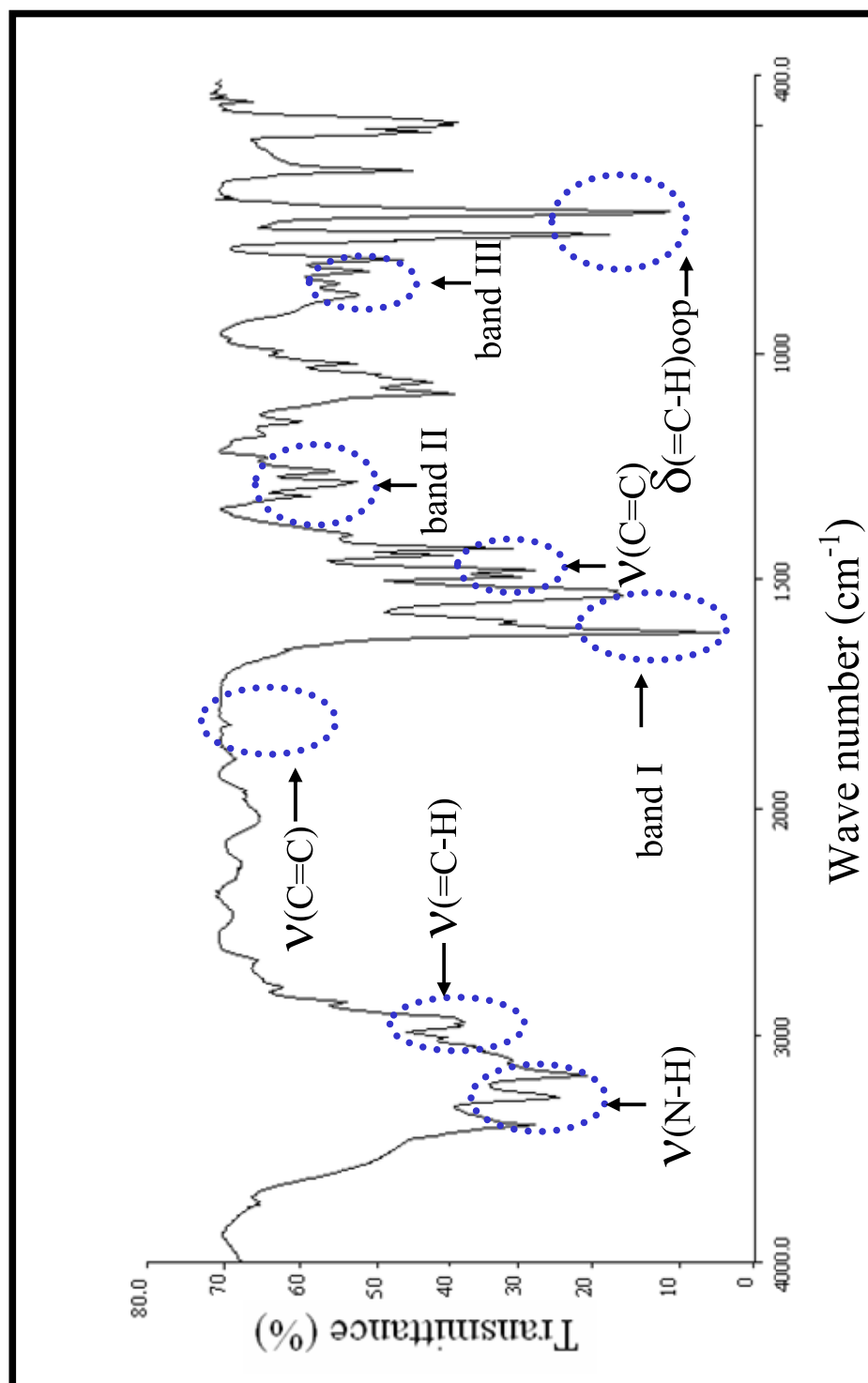
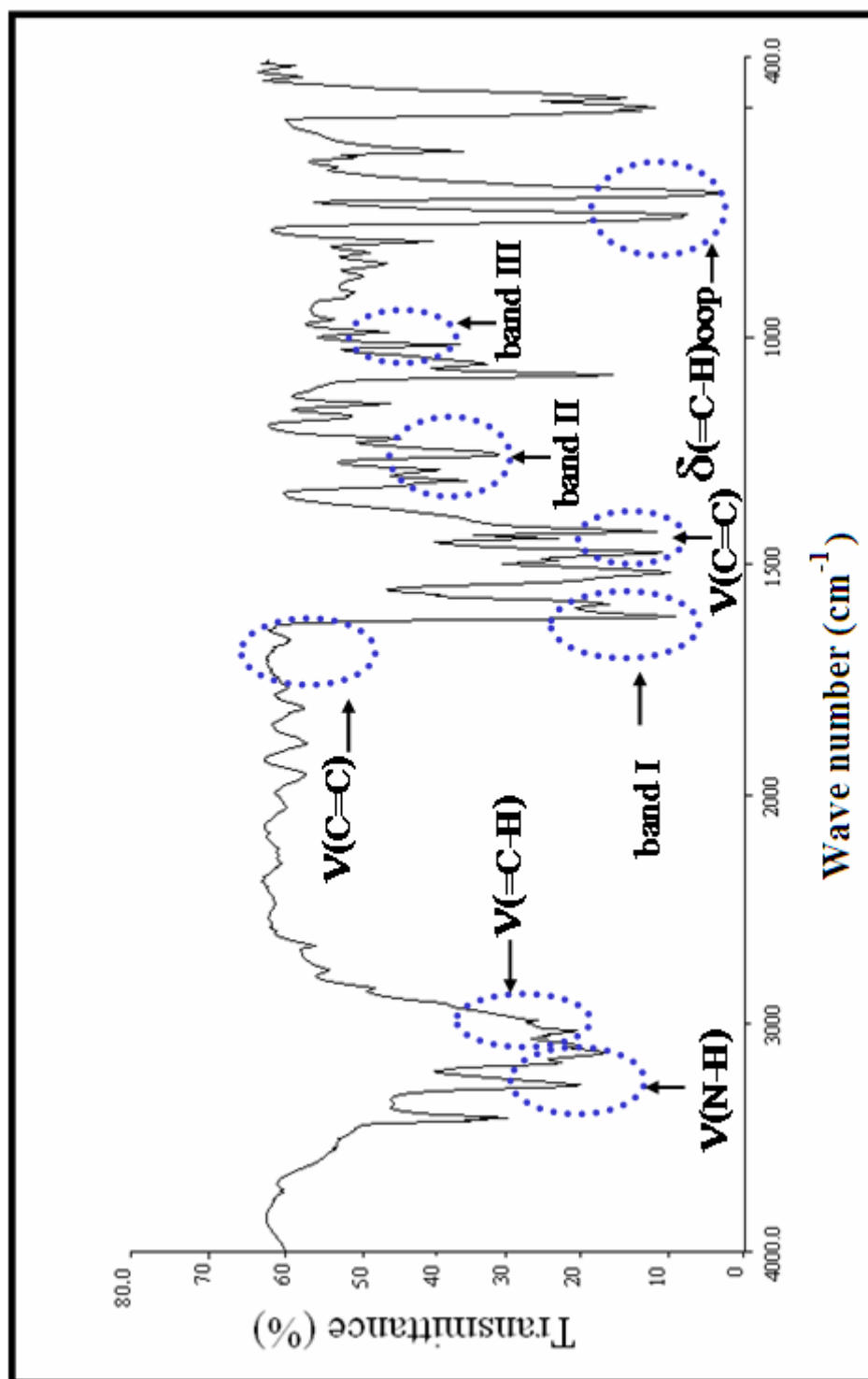

Figure 40 The infrared spectrum of Triphenylphosphine (PPh₃).

Figure 41 The infrared spectrum of $[\text{CuCl}(\text{PPH}_3)_2(\text{PTU})]$.

Figure 42 The infrared spectrum of [CuBr(PPh₃)₂(ptu)].

Figure 43 The infrared spectrum of $[\text{CuI}(\text{PPh}_3)_2(\text{ptu})]$.

3.5 ^1H NMR and ^{13}C NMR Spectroscopy

The ^1H NMR and ^{13}C NMR Spectra of the ligands and compounds are shown in Figures 44-53.

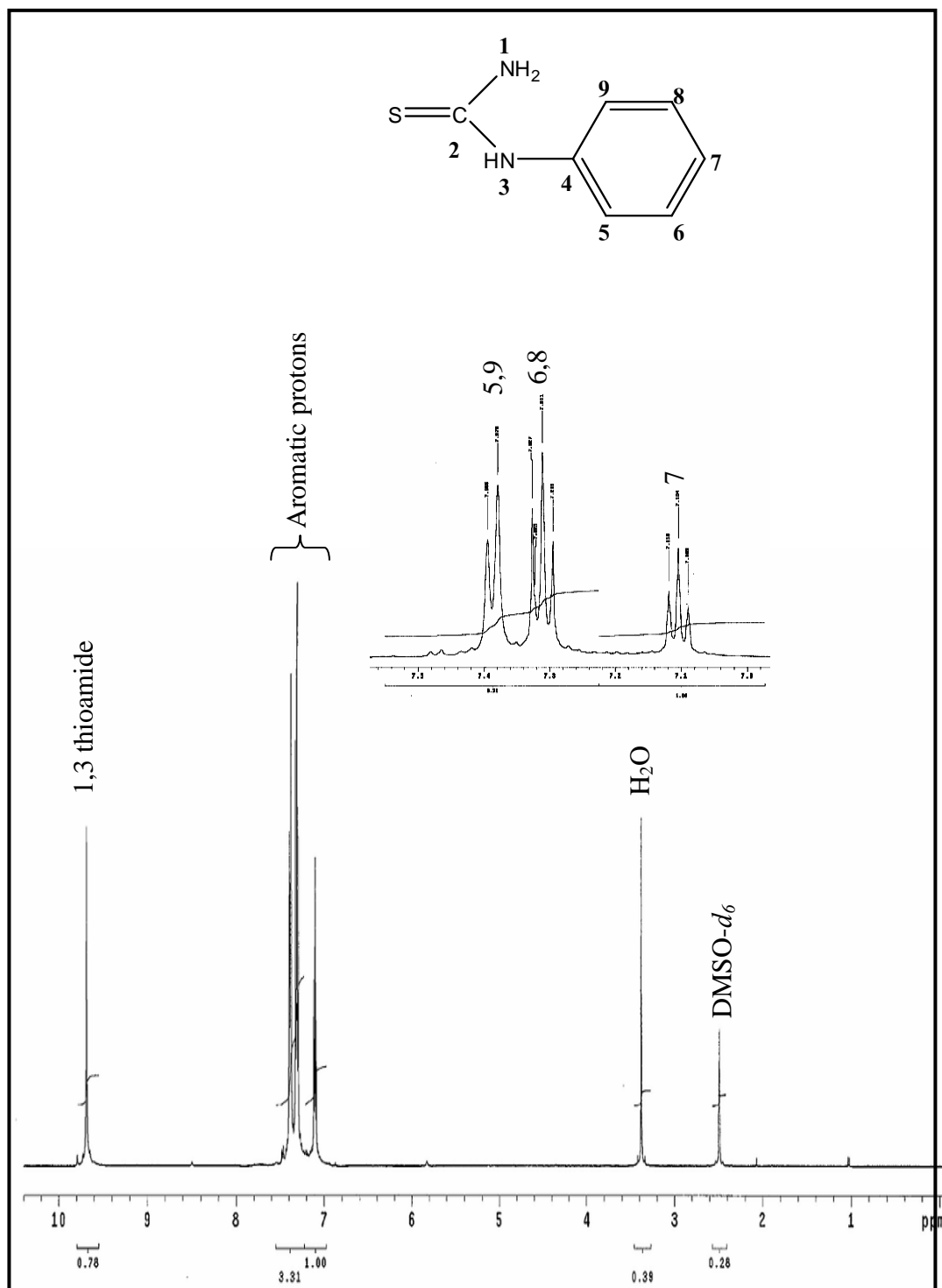

Figure 44 ^1H NMR spectrum of *N*-phenylthiourea(ptu).

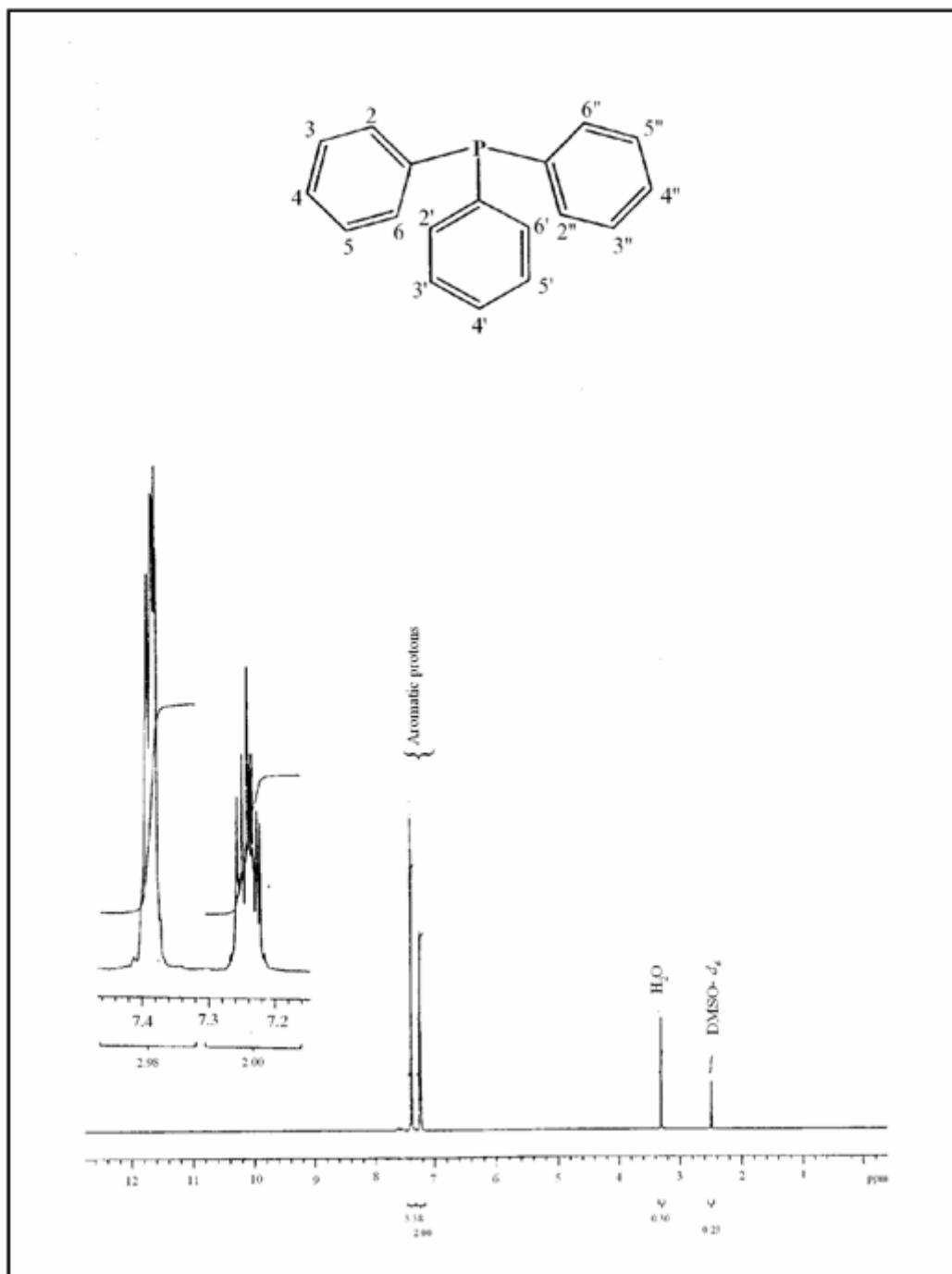
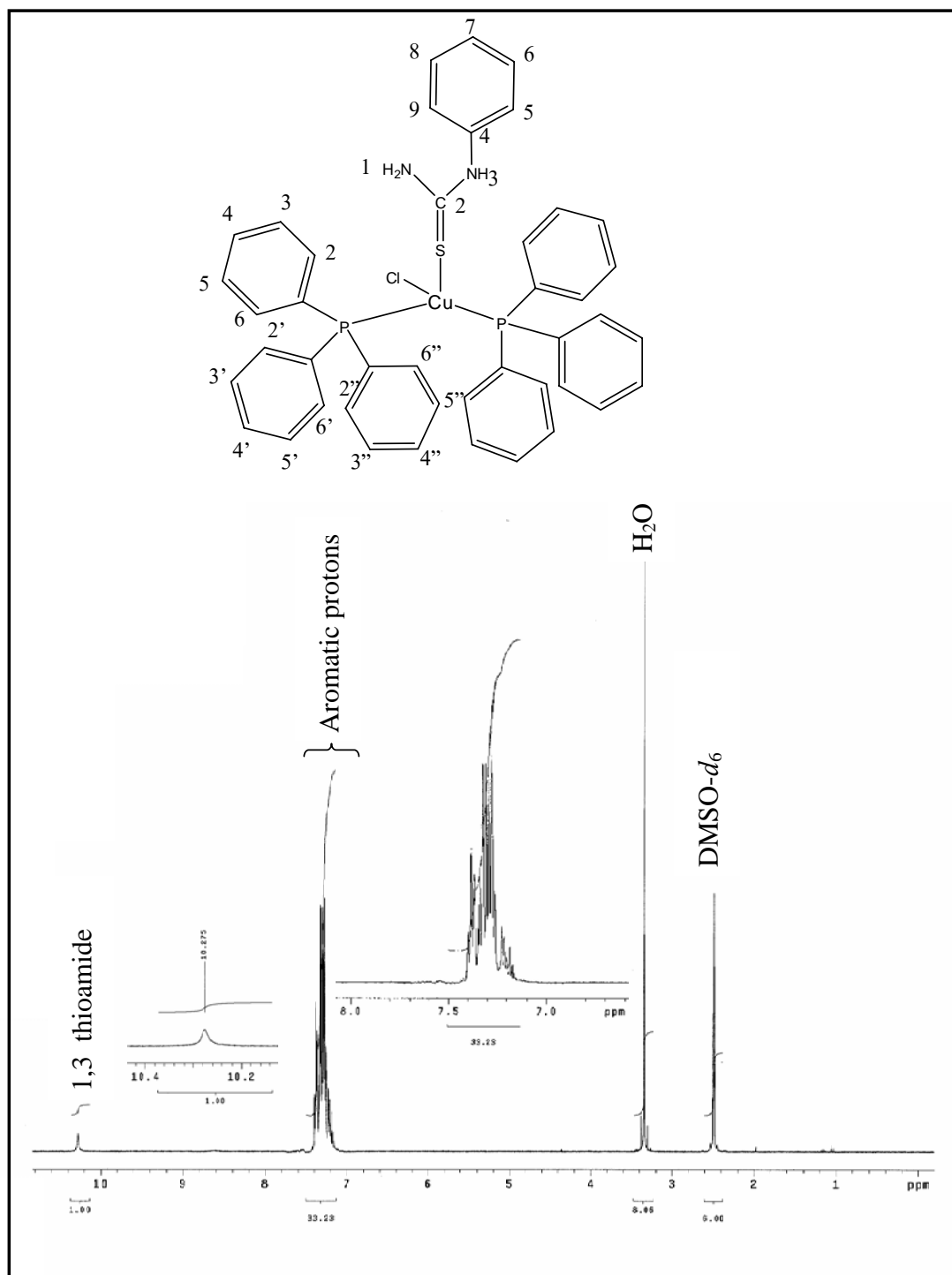
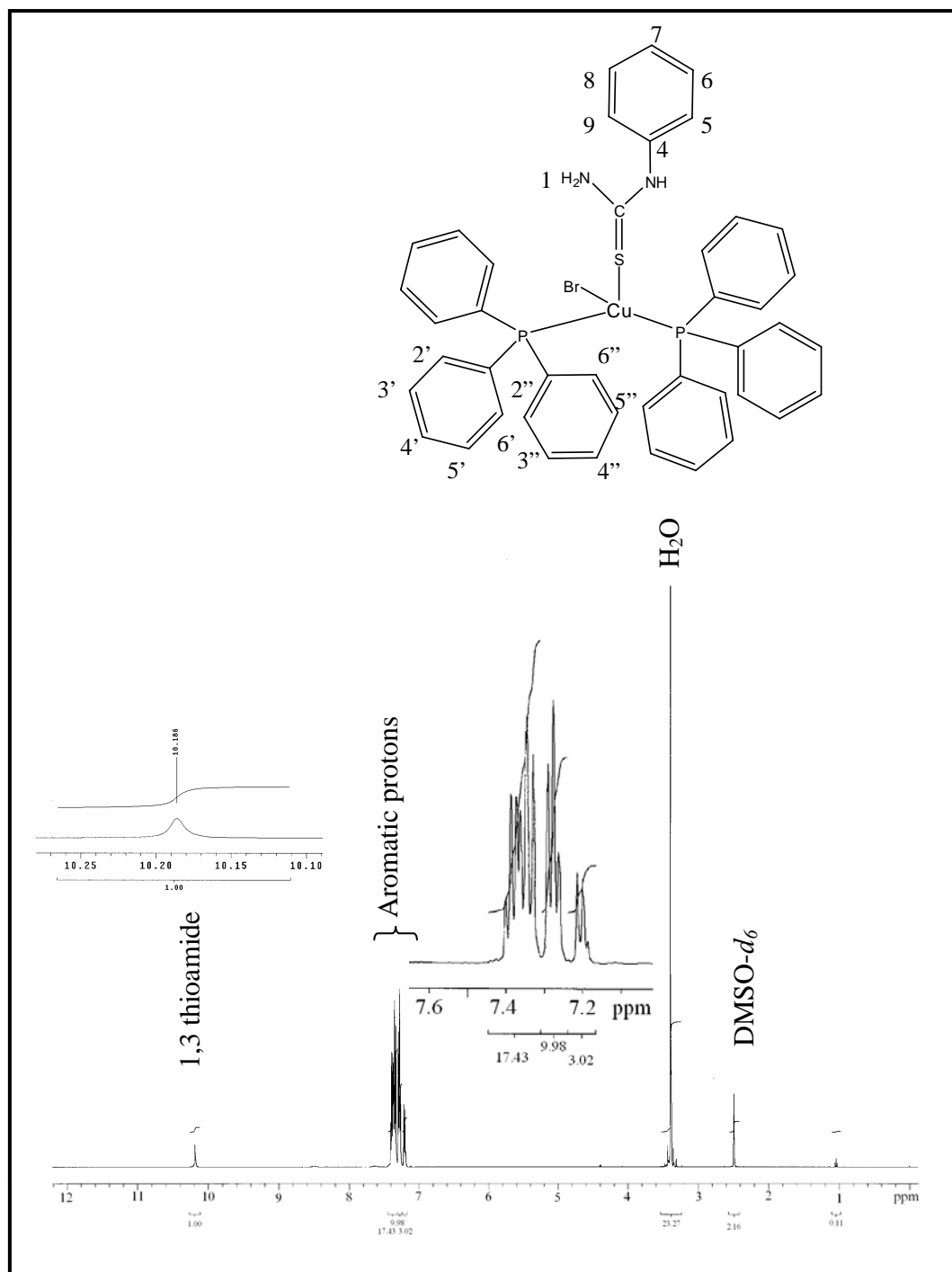

Figure 45 ¹H NMR spectrum of Triphenylphosphine(PPh₃).

Figure 46 ^1H NMR spectrum of $[\text{CuCl}(\text{PPh}_3)_2(\text{ptu})]$.

Figure 47 ^1H NMR spectrum of $[\text{CuBr}(\text{PPh}_3)_2(\text{ptu})]$.

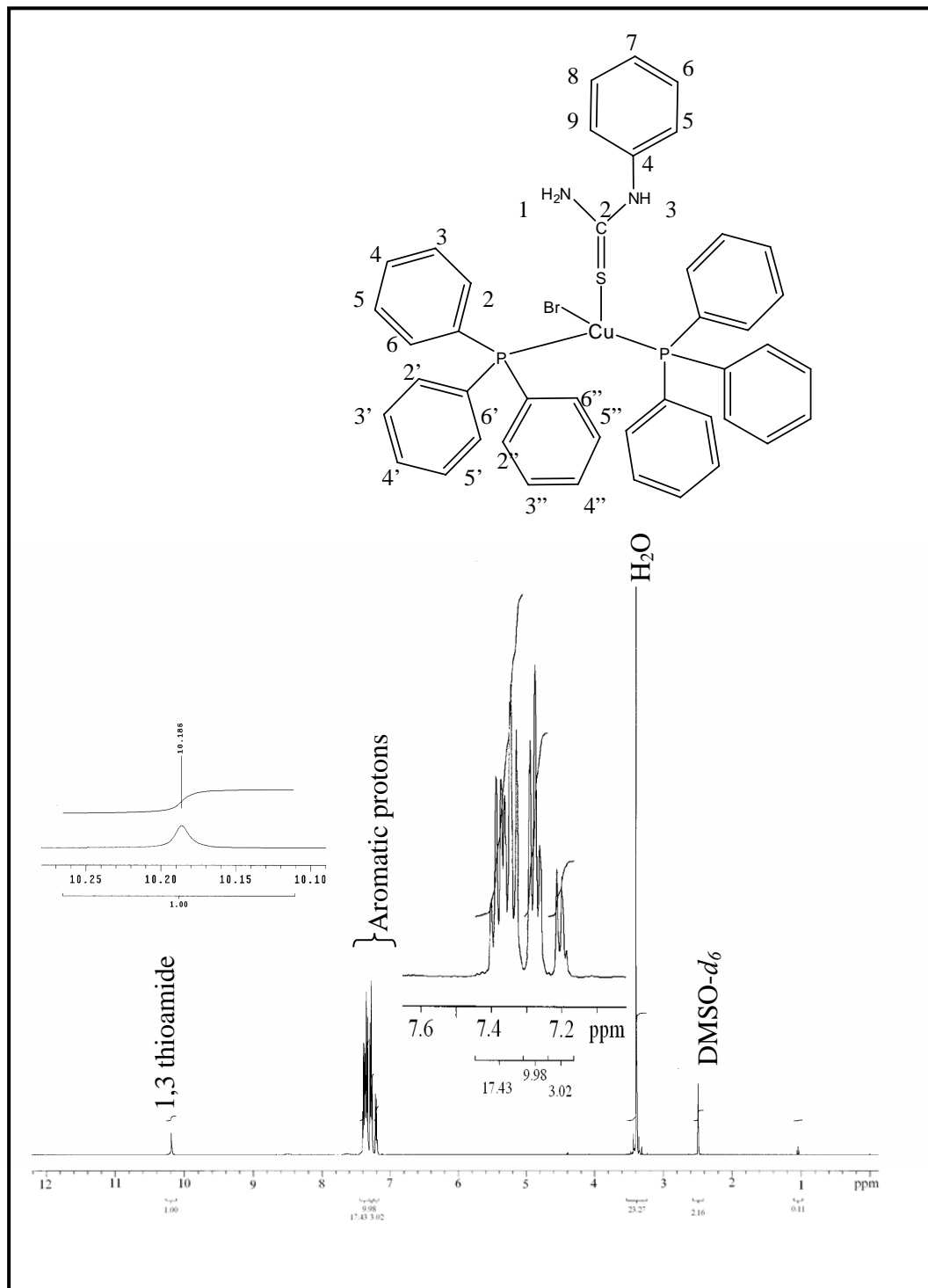

Figure 48 ^1H NMR spectrum of $[\text{CuI}(\text{PPh}_3)_2(\text{ptu})]$.

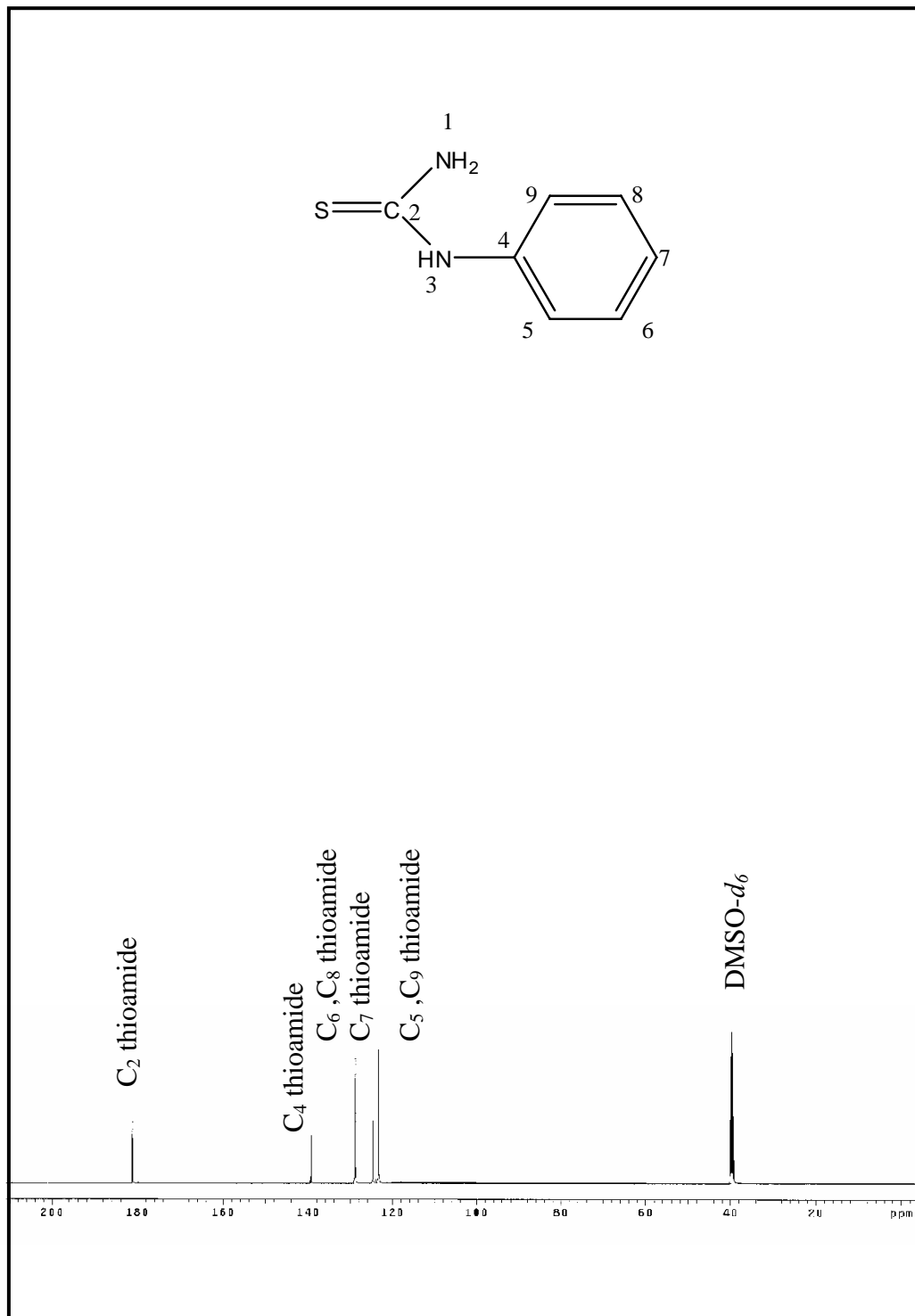

Figure 49 ¹³C NMR spectrum of *N*-phenylthiourea (ptu).

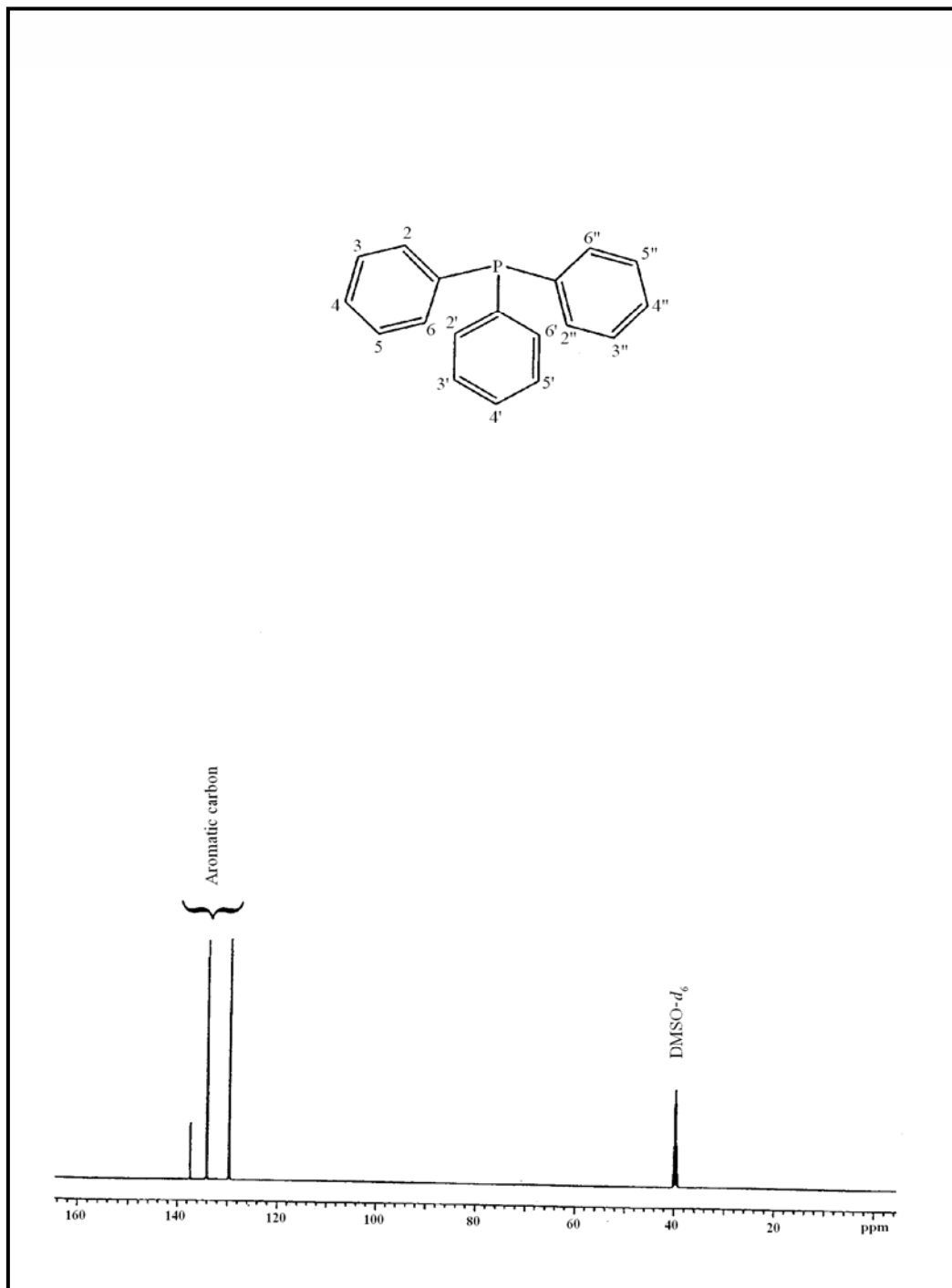
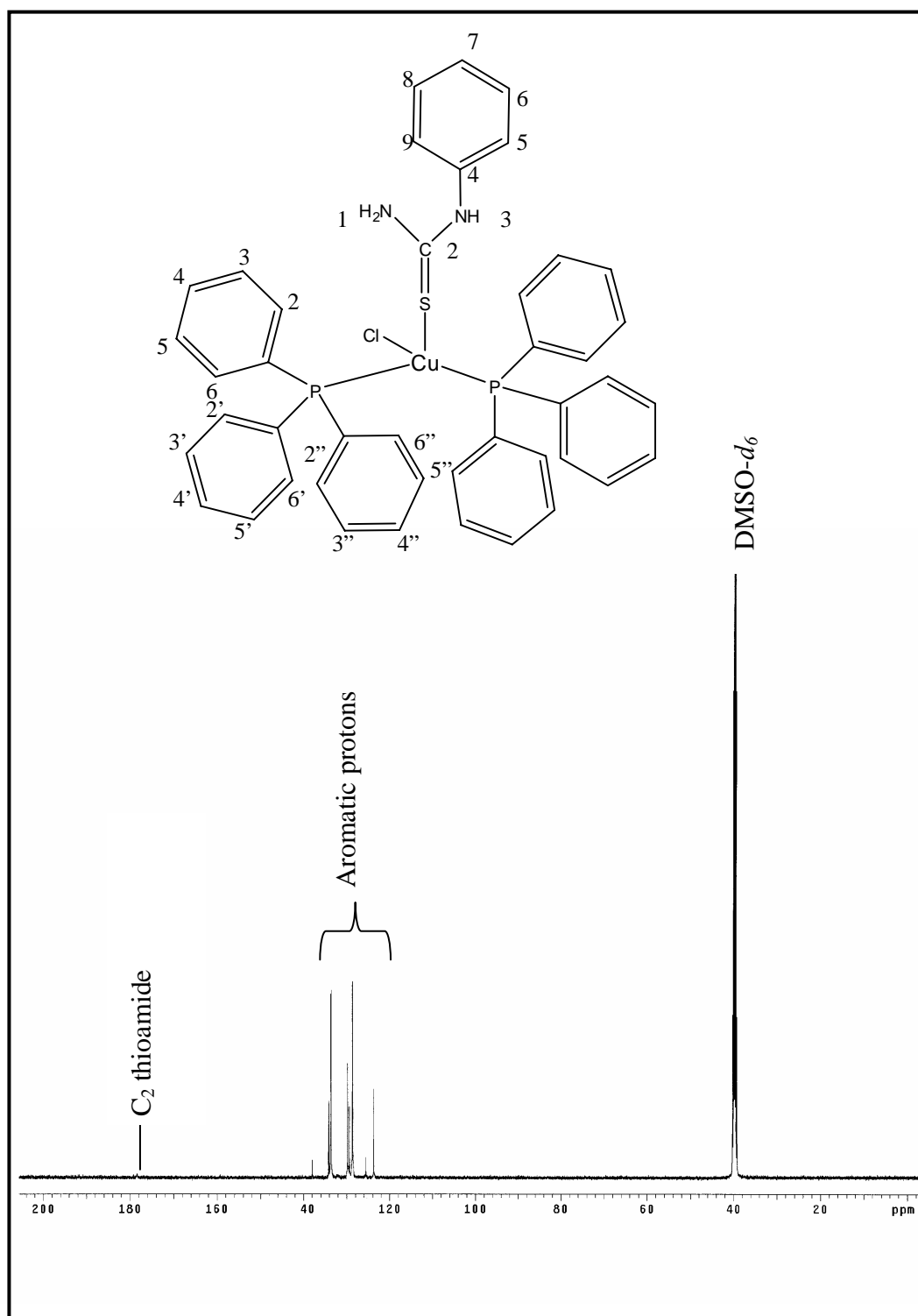

Figure 50 ^{13}C NMR spectrum of Triphenylphosphine (PPh_3).

Figure 51 ^{13}C NMR spectrum of $[\text{CuCl}(\text{PPh}_3)_2(\text{ptu})]$.

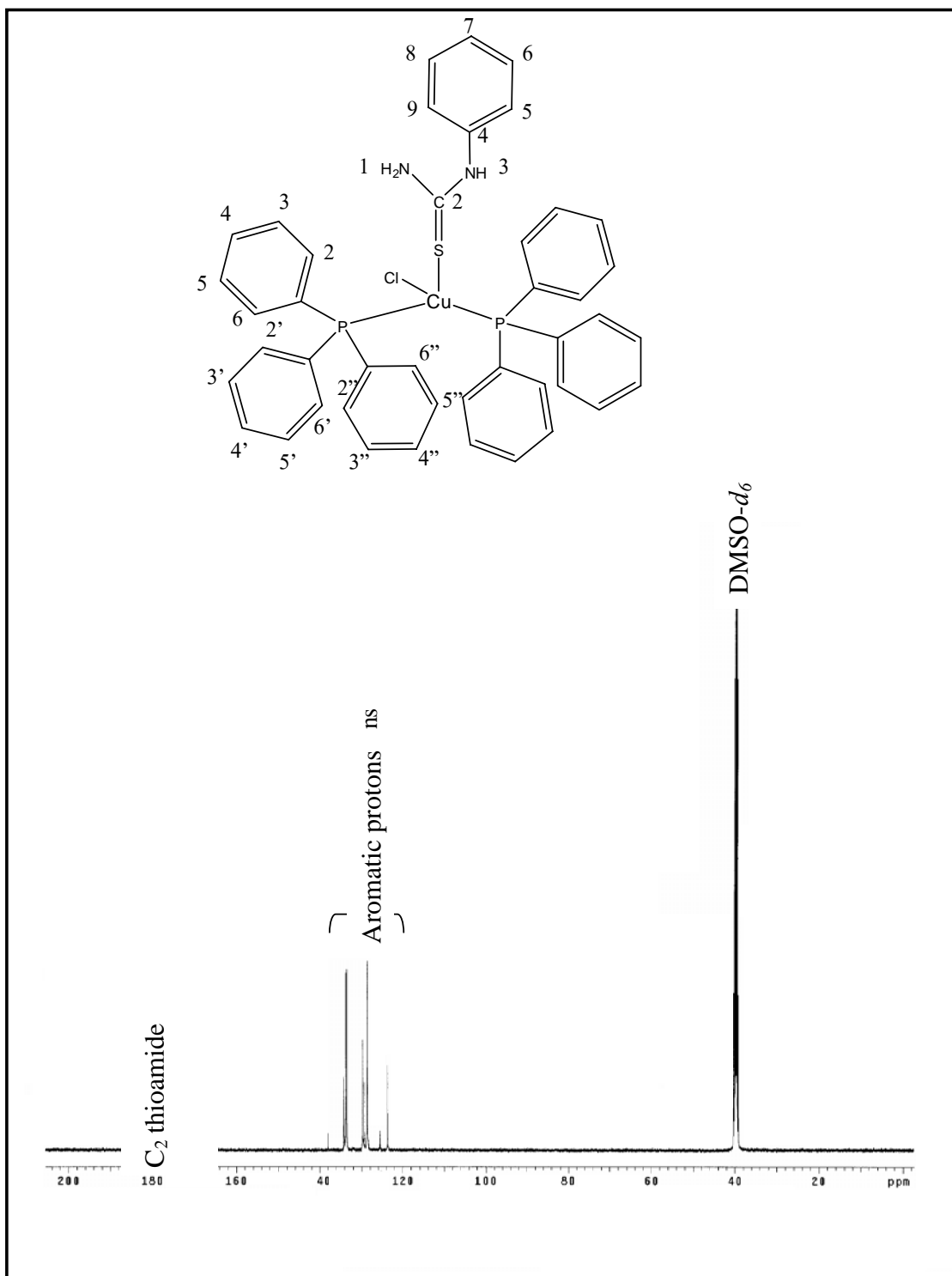
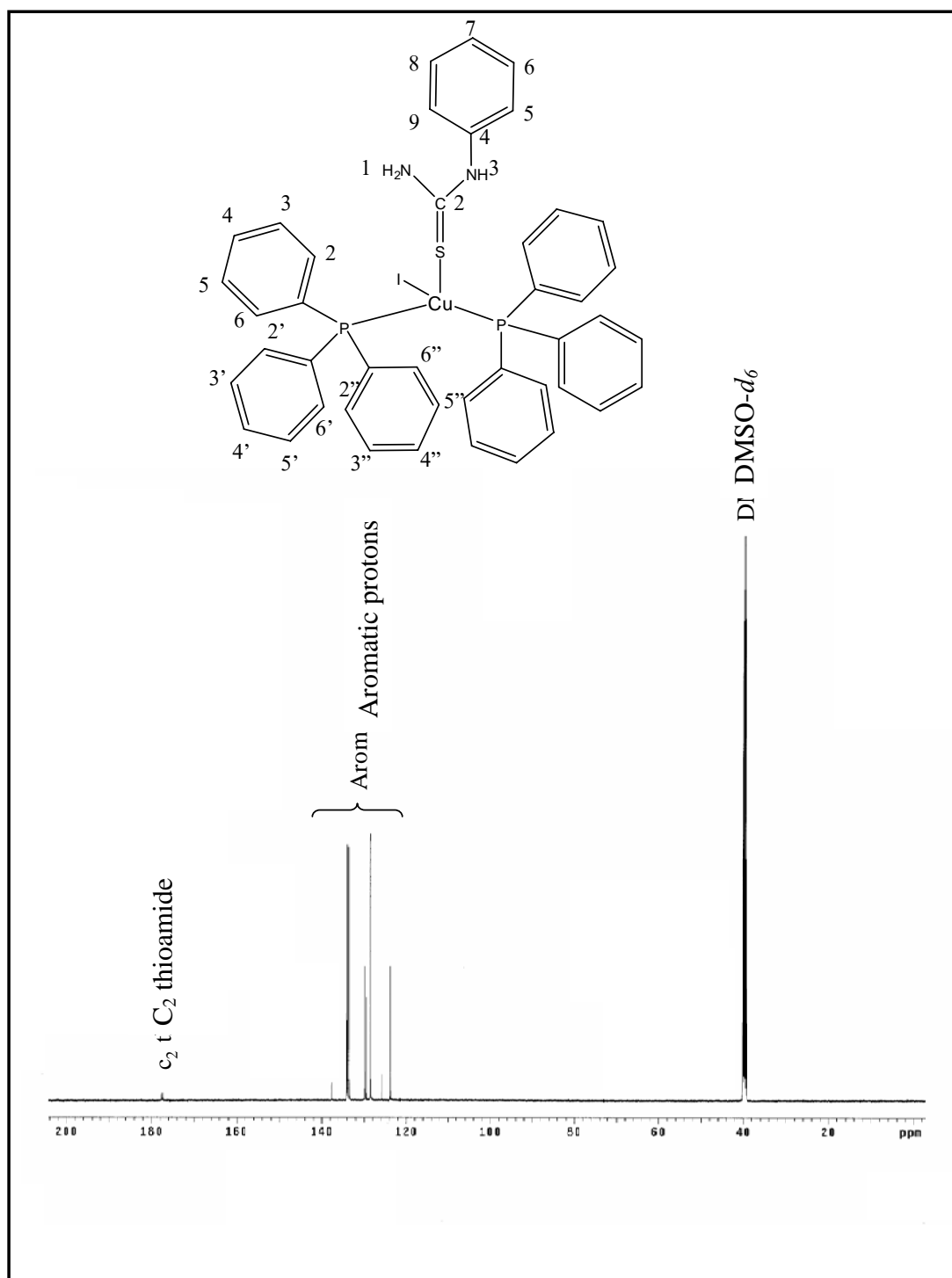

Figure 52 ^{13}C NMR spectrum of $[\text{CuBr}(\text{PPh}_3)_2(\text{ptu})]$.

Figure 53 ^{13}C NMR spectrum of $[\text{CuI}(\text{PPh}_3)_2(\text{ptu})]$.

3.6 Single crystal X-ray diffractometry

3.6.1 Crystal Structures

These results from crystal structure determination using Xtal program System of complex 1, 2 and 3 are shown in Table 5, 8 and 11, respectively, and Figure 54-59.

Table 5 The crystallographic data for [CuX(PPh₃)₂(ptu)] (X = Cl and Br).

Empirical formula	C ₄₃ H ₃₈ CuClN ₂ P ₂ S	C ₄₃ H ₃₈ CuBrN ₂ P ₂ S
Formula weight	775.83	820.28
Crystal system	Triclinic	Triclinic
Space group	$P\bar{1}$	$P\bar{1}$
Unit cell dimensions		
a (Å)	10.5226 (1)	10.6236 (4)
b (Å)	11.3035 (2)	11.2135 (4)
c (Å)	17.1848 (2)	17.1481 (7)
α (°)	97.609 (1)	97.957 (1)
β (°)	103.508 (1)	102.424 (1)
γ (°)	103.609 (1)	102.944 (1)
V (Å ³)	1893.3 (6)	1906.6 (2)
Z	2	2
Density (calculated) (g cm ⁻³)	0.68	0.714
Absorbtion coefficient (mm ⁻¹)	0.410	0.896
Final R indices [$I > 2\sigma(I)$]	$R1 = 0.031$ $wR2 = 0.032$	$R1 = 0.045$ $wR2 = 0.1175$
R indices (all data)		$R1 = 0.076,$ $wR2 = 0.1452$
$F(000)$	804	840
Goodness-of-fit		0.910
Data/ restraints / parameters		9109/0/603

Table 6 Non - hydrogen interatomic distances of [CuCl(PPh₃)₂(ptu)].

Atom	Distance (Å)
Cu(1)-Cl(1)	2.3505(7)
Cu(1)-S(1)	2.4722(6)
Cu(1)-P(1)	2.2941(6)
Cu(1)-P(2)	2.3208(6)
S(1)-C(1)	1.715(2)
P(1)-C(11)	1.831(2)
P(1)-C(21)	1.838(2)
P(1)-C(31)	1.830(3)
P(2)-C(41)	1.842(2)
P(2)-C(51)	1.825(2)
P(2)-C(61)	1.840(2)
C(1)-N(1)	1.327(3)
C(1)-N(2)	1.322(3)
N(1)-C(2)	1.440(3)
C(2)-C(3)	1.381(4)
C(2)-C(7)	1.370(3)
C(3)-C(4)	1.393(5)
C(4)-C(5)	1.363(4)
C(5)-C(6)	1.357(5)
C(6)-C(7)	1.378(4)
C(11)-C(12)	1.393(4)
C(11)-C(16)	1.396(4)
C(12)-C(13)	1.379(4)
C(13)-C(14)	1.370(5)

C(14)-C(15)	1.368(6)
C(15)-C(16)	1.394(4)

Table 6 (continued).

Atom	Distance (Å)
C(21)-C(22)	1.387(4)
C(21)-C(26)	1.385(4)
C(22)-C(23)	1.398(4)
C(23)-C(24)	1.366(6)
C(24)-C(25)	1.360(5)
C(25)-C(26)	1.398(4)
C(31)-C(32)	1.394(3)
C(31)-C(36)	1.384(4)
C(32)-C(33)	1.378(5)
C(33)-C(34)	1.367(5)
C(34)-C(35)	1.369(4)
C(35)-C(36)	1.398(5)
C(41)-C(42)	1.391(4)
C(41)-C(46)	1.381(3)
C(42)-C(43)	1.392(5)
C(43)-C(44)	1.368(3)
C(44)-C(45)	1.366(5)
C(45)-C(46)	1.399(4)
C(51)-C(52)	1.401(4)
C(51)-C(56)	1.397(4)
C(52)-C(53)	1.383(4)
C(53)-C(54)	1.378(6)
C(54)-C(55)	1.362(6)

C(55)-C(56)	1.385(4)
C(61)-C(62)	1.375(4)
C(61)-C(66)	1.350(3)

Table 6 (continued).

Atom	Distance (Å)
C(62)-C(63)	1.386(6)
C(63)-C(64)	1.362(5)
C(64)-C(65)	1.335(6)
C(65)-C(66)	1.386(5)

Table 7 Non - hydrogen inerbond angles of [CuCl(PPh₃)₂(ptu)].

Atom	Angle (°)
Cl(1)-Cu(1)-S(1)	102.31(2)
Cl(1)-Cu(1)-P(1)	114.80(2)
Cl(1)-Cu(1)-P(2)	108.14(2)
S(1)-Cu(1)-P(1)	97.35(2)
S(1)-Cu(1)-P(2)	111.55(2)
P(1)-Cu(1)-P(2)	120.67(2)
Cu(1)-S(1)-C(1)	107.18(7)
Cu(1)-P(1)-C(11)	118.75(9)
Cu(1)-P(1)-C(21)	118.12(7)
Cu(1)-P(1)-C(31)	109.13(6)
C(11)-P(1)-C(21)	98.34(9)
C(11)-P(1)-C(31)	107.4(1)
C(21)-P(1)-C(31)	103.5(1)
Cu(1)-P(2)-C(41)	117.68(8)
Cu(1)-P(2)-C(51)	112.50(7)
Cu(1)-P(2)-C(61)	117.34(6)
C(41)-P(2)-C(51)	103.67(9)
C(41)-P(2)-C(61)	99.9(1)
C(51)-P(2)-C(61)	103.7(1)
S(1)-C(1)-N(1)	120.4(1)
S(1)-C(1)-N(2)	120.8(2)

N(1)-C(1)-N(2)	118.9(2)
C(1)-N(1)-C(2)	126.0(2)
N(1)-C(2)-C(3)	120.5(2)
N(1)-C(2)-C(7)	119.6(2)
C(3)-C(2)-C(7)	119.7(2)

Table 7 (continued).

Atom	Angle (°)
C(2)-C(3)-C(4)	119.3(2)
C(3)-C(4)-C(5)	120.2(3)
C(4)-C(5)-C(6)	120.1(3)
C(5)-C(6)-C(7)	120.6(3)
C(2)-C(7)-C(6)	120.1(3)
P(1)-C(11)-C(12)	118.7(2)
P(1)-C(11)-C(16)	121.9(2)
C(12)-C(11)-C(16)	118.9(2)
C(11)-C(12)-C(13)	120.3(3)
C(12)-C(13)-C(14)	120.8(4)
C(13)-C(14)-C(15)	119.8(3)
C(14)-C(15)-C(16)	120.7(3)
C(11)-C(16)-C(15)	119.6(3)
P(1)-C(21)-C(22)	116.6(2)
P(1)-C(21)-C(26)	124.8(2)
C(22)-C(21)-C(26)	118.6(2)
C(21)-C(22)-C(23)	120.6(3)
C(22)-C(23)-C(24)	120.0(3)
C(23)-C(24)-C(25)	120.1(3)
C(24)-C(25)-C(26)	120.7(4)

C(21)-C(26)-C(25)	120.0(3)
P(1)-C(31)-C(32)	116.3(2)
P(1)-C(31)-C(36)	125.8(2)
C(32)-C(31)-C(36)	117.8(2)
C(31)-C(32)-C(33)	121.3(3)
C(32)-C(33)-C(34)	120.3(3)

Table 7 (continued)

Atom	Angle (°)
C(33)-C(34)-C(35)	119.5(3)
C(34)-C(35)-C(36)	120.7(3)
C(31)-C(36)-C(35)	120.1(3)
P(2)-C(41)-C(42)	117.2(1)
P(2)-C(41)-C(46)	123.9(2)
C(42)-C(41)-C(46)	118.8(2)
C(41)-C(42)-C(43)	120.3(2)
C(42)-C(43)-C(44)	120.4(3)
C(43)-C(44)-C(45)	119.9(3)
C(44)-C(45)-C(46)	120.5(2)
C(41)-C(46)-C(45)	120.1(3)
P(2)-C(51)-C(52)	118.2(2)
P(2)-C(51)-C(56)	124.2(2)
C(52)-C(51)-C(56)	117.5(2)
C(51)-C(52)-C(53)	121.4(3)
C(52)-C(53)-C(54)	119.4(3)
C(53)-C(54)-C(55)	120.3(3)
C(54)-C(55)-C(56)	121.0(4)
C(51)-C(56)-C(55)	120.3(3)

P(2)-C(61)-C(62)	122.5(2)
P(2)-C(61)-C(66)	120.4(2)
C(62)-C(61)-C(66)	117.0(2)
C(61)-C(62)-C(63)	121.0(3)
C(62)-C(63)-C(64)	120.1(4)
C(63)-C(64)-C(65)	119.3(4)
C(64)-C(65)-C(66)	120.4(3)

Table 7 (continued).

Atom	Angle (°)
C(61)-C(66)-C(65)	122.1(3)

Table 8 Non - hydrogen interatomic distances of [CuBr(PPh₃)₂(ptu)].

Atom	Distance (Å)
Cu(1)-Br(1)	2.4737(5)
Cu(1)-S(1)	2.4387(8)
Cu(1)-P(1)	2.2936(8)
Cu(1)-P(2)	2.3173(8)
S(1)-C(1)	1.708(3)
P(1)-C(11)	1.827(3)
P(1)-C(21)	1.831(3)
P(1)-C(31)	1.821(3)
P(2)-C(41)	1.839(3)
P(2)-C(51)	1.829(3)
P(2)-C(61)	1.835(3)
C(1)-N(1)	1.324(4)
C(1)-N(2)	1.323(4)
N(1)-C(2)	1.430(4)
C(2)-C(3)	1.371(5)
C(2)-C(7)	1.376(5)
C(3)-C(4)	1.384(6)
C(4)-C(5)	1.353(7)
C(5)-C(6)	1.358(7)
C(6)-C(7)	1.367(6)
C(11)-C(12)	1.377(5)
C(11)-C(16)	1.390(5)
C(12)-C(13)	1.387(5)
C(13)-C(14)	1.372(6)
C(14)-C(15)	1.372(8)
C(15)-C(16)	1.384(5)

Table 8 (continued).

Atom	Distance (Å)
C(21)-C(22)	1.390(5)
C(21)-C(26)	1.389(6)
C(22)-C(23)	1.388(5)
C(23)-C(24)	1.371(8)
C(24)-C(25)	1.358(8)
C(25)-C(26)	1.390(6)
C(31)-C(32)	1.394(4)
C(31)-C(36)	1.387(5)
C(32)-C(33)	1.370(5)
C(33)-C(34)	1.374(6)
C(34)-C(35)	1.357(5)
C(35)-C(36)	1.397(6)
C(41)-C(42)	1.386(5)
C(41)-C(46)	1.387(3)
C(42)-C(43)	1.378(6)
C(43)-C(44)	1.377(4)
C(44)-C(45)	1.364(6)
C(45)-C(46)	1.385(5)
C(51)-C(52)	1.395(5)
C(51)-C(56)	1.393(5)
C(52)-C(53)	1.380(5)
C(53)-C(54)	1.367(7)
C(54)-C(55)	1.373(7)
C(55)-C(56)	1.395(5)

C(61)-C(62)	1.392(5)
C(61)-C(66)	1.353(4)

Table 8 (continued).

Atom	Distance (Å)
C(62)-C(63)	1.388(7)
C(63)-C(64)	1.364(6)
C(64)-C(65)	1.337(8)
C(65)-C(66)	1.393(6)

Table 9 Non - hydrogen inerbond angles of [CuBr(PPh₃)₂(ptu)].

Atom	Angle (°)
Br(1)-Cu(1)-S(1)	104.89(3)
Br(1)-Cu(1)-P(1)	112.53(2)
Br(1)-Cu(1)-P(2)	107.04(3)
S(1)-Cu(1)-P(1)	98.57(3)
S(1)-Cu(1)-P(2)	111.66(3)
P(1)-Cu(1)-P(2)	120.92(3)
Cu(1)-S(1)-C(1)	108.0(1)
Cu(1)-P(1)-C(11)	119.8(1)
Cu(1)-P(1)-C(21)	117.1(1)
Cu(1)-P(1)-C(31)	109.00(8)
C(11)-P(1)-C(21)	98.2(1)
C(11)-P(1)-C(31)	107.4(1)
C(21)-P(1)-C(31)	103.7(1)
Cu(1)-P(2)-C(41)	118.3(1)
Cu(1)-P(2)-C(51)	112.8(1)
Cu(1)-P(2)-C(61)	116.65(8)
C(41)-P(2)-C(51)	103.3(1)
C(41)-P(2)-C(61)	99.0(1)
C(51)-P(2)-C(61)	104.9(1)
S(1)-C(1)-N(1)	121.0(2)
S(1)-C(1)-N(2)	120.3(3)
N(1)-C(1)-N(2)	118.7(3)

C(1)-N(1)-C(2)	126.8(2)
N(1)-C(2)-C(3)	120.7(3)
N(1)-C(2)-C(7)	119.8(3)
C(3)-C(2)-C(7)	119.3(3)

Table 9 (continued).

Atom	Angle (°)
C(2)-C(3)-C(4)	119.3(4)
C(3)-C(4)-C(5)	120.7(4)
C(4)-C(5)-C(6)	120.0(4)
C(5)-C(6)-C(7)	120.3(4)
C(2)-C(7)-C(6)	120.3(4)
P(1)-C(11)-C(12)	119.4(2)
P(1)-C(11)-C(16)	121.5(3)
C(12)-C(11)-C(16)	118.6(3)
C(11)-C(12)-C(13)	120.8(3)
C(12)-C(13)-C(14)	120.2(4)
C(13)-C(14)-C(15)	119.6(4)
C(14)-C(15)-C(16)	120.5(4)
C(11)-C(16)-C(15)	120.3(4)
P(1)-C(21)-C(22)	116.6(3)
P(1)-C(21)-C(26)	124.8(2)
C(22)-C(21)-C(26)	118.6(3)
C(21)-C(22)-C(23)	120.4(4)
C(22)-C(23)-C(24)	120.0(4)
C(23)-C(24)-C(25)	120.3(4)
C(24)-C(25)-C(26)	120.6(5)
C(21)-C(26)-C(25)	120.0(4)

P(1)-C(31)-C(32)	116.4(2)
P(1)-C(31)-C(36)	126.1(2)
C(32)-C(31)-C(36)	117.4(3)
C(31)-C(32)-C(33)	122.3(3)

Table 9 (continued).

Atom	Angle (°)
C(32)-C(33)-C(34)	119.2(3)
C(33)-C(34)-C(35)	120.1(4)
C(34)-C(35)-C(36)	121.0(4)
C(31)-C(36)-C(35)	119.8(3)
P(2)-C(41)-C(42)	117.4(2)
P(2)-C(41)-C(46)	124.6(3)
C(42)-C(41)-C(46)	117.9(3)
C(41)-C(42)-C(43)	120.9(3)
C(42)-C(43)-C(44)	120.4(4)
C(43)-C(44)-C(45)	119.6(4)
C(44)-C(45)-C(46)	120.3(3)
C(41)-C(46)-C(45)	120.9(3)
P(2)-C(51)-C(52)	117.5(2)
P(2)-C(51)-C(56)	124.6(2)
C(52)-C(51)-C(56)	117.8(3)
C(51)-C(52)-C(53)	121.4(4)
C(52)-C(53)-C(54)	120.0(4)
C(53)-C(54)-C(55)	120.1(4)
C(54)-C(55)-C(56)	120.4(4)
C(51)-C(56)-C(55)	120.2(4)
P(2)-C(61)-C(62)	122.1(2)

P(2)-C(61)-C(66)	120.1(3)
C(62)-C(61)-C(66)	117.8(3)
C(61)-C(62)-C(63)	120.5(3)
C(62)-C(63)-C(64)	119.8(5)

Table 9 (continued).

Atom	Angle (°)
C(63)-C(64)-C(65)	120.0(5)
C(64)-C(65)-C(66)	120.5(4)
C(61)-C(66)-C(65)	121.2(4)

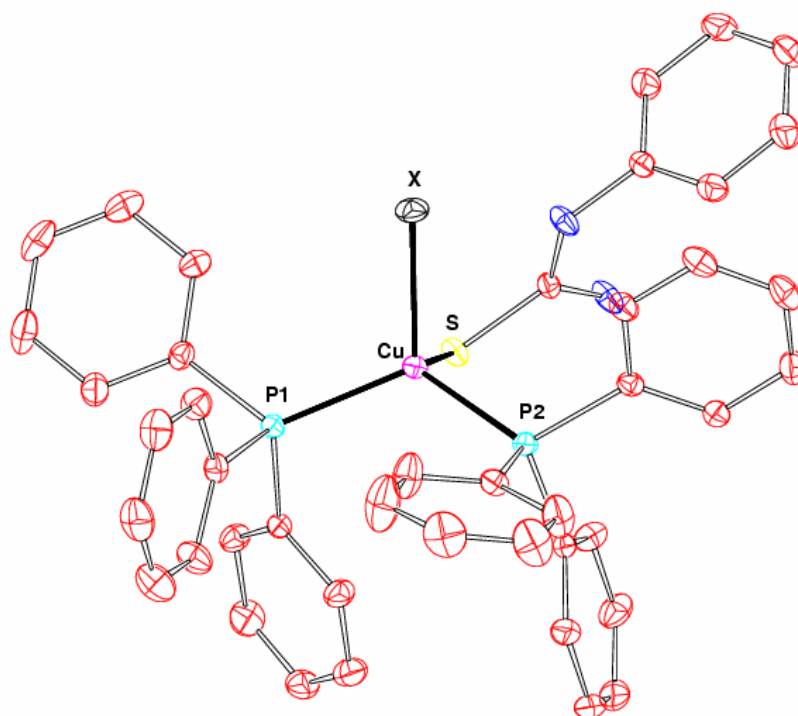

Figure 54 The structure of [CuX(PPh₃)₂(ptu)] (X = Cl and Br). Ellipsoids are drawn at the 50% probability level.

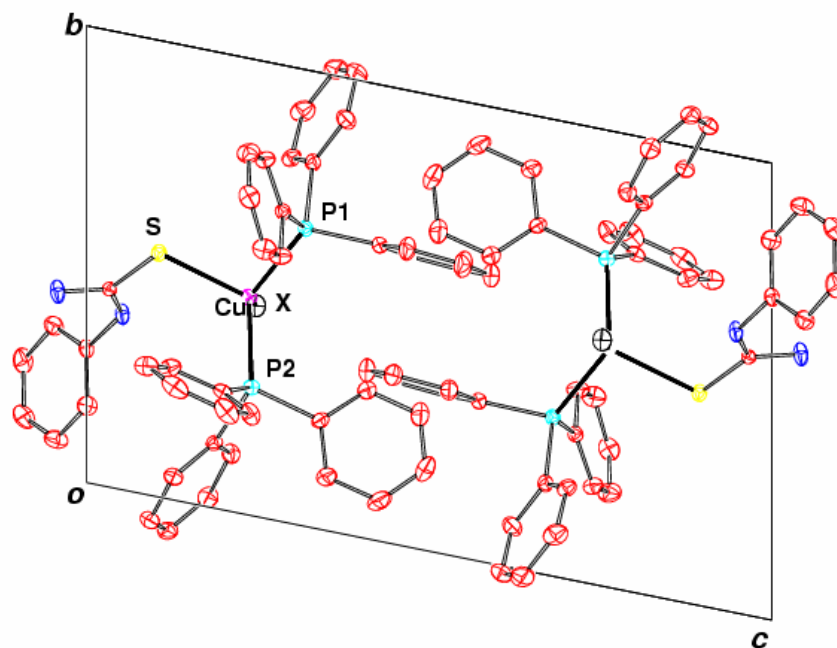

Figure 55 Unit cell contents of $[\text{CuX}(\text{PPh}_3)_2(\text{ptu})]$ ($\text{X} = \text{Cl}$ and Br) projected down a . The hydrogen atoms are omitted for clarity.

Table 10 The crystallographic data for $[\text{CuI}(\text{PPh}_3)_2(\text{ptu})]$.

Empirical formula	$\text{C}_{43}\text{H}_{38}\text{CuIN}_2\text{P}_2\text{S}$
Formula weight	867.19
Crystal system	Triclinic
Space group	$P\bar{1}$
Unit cell dimensions	
a (Å)	10.9505 (9)
b (Å)	18.7294(15)
c (Å)	21.3731 (18)
α (°)	67.4220 (10)
β (°)	77.2150 (10)
γ (°)	73.2240 (10)
V (Å ³)	3844.9 (5)
Z	4

Density (calculated) (g cm ⁻³)	1.498
Absorption coefficient (mm ⁻¹)	1.542 mm ⁻¹
Crystal size	0.50 x 0.30 x 0.07 mm ³
Final <i>R</i> indices [<i>I</i> >2σ(<i>I</i>)]	<i>R</i> 1=0.053, <i>wR</i> 2=0.0852
<i>R</i> indices (all data)	<i>R</i> 1=0.1218, <i>wR</i> 2=0.1077
<i>F</i> (000)	1752
Reflections collected	42789
Goodness-of-fit	0.983
Data/ restraints / parameters	15698/ 0 /901
Independent reflections	15698 [<i>R</i> (int)=0.0885]
Largest diff. peak and hole	0.823 and -0.743 e. Å ⁻³

Table 11 Non – hydrogen interatomic distances of [CuI(PPh₃)₂(ptu)].

Atom	Distance (Å)
Molecule 1	
Cu(1)-P(1)	2.2908 (15)
Cu(1)-P(2)	2.3024 (16)
Cu(1)-S(1)	2.4148 (16)
Cu(1)-I(1)	2.6658 (8)
S(1)-C(1)	1.701 (5)
N(1)-C(1)	1.329 (6)
N(2)-C(1)	1.335 (6)
N(2)-C(2)	1.438 (7)
P(1)-C(20)	1.824 (5)

P(1)-C(14)	1.830 (5)
P(1)-C(8)	1.841 (5)
P(2)-C(32)	1.833 (5)
P(2)-C(26)	1.834 (5)
P(2)-C(38)	1.836 (5)
C(2)-C(3)	1.379 (7)
C(2)-C(7)	1.396 (7)
C(3)-C(4)	1.383 (7)
C(4)-C(5)	1.373 (8)
C(5)-C(6)	1.366 (8)
C(6)-C(7)	1.391 (7)
C(8)-C(9)	1.385 (7)
C(8)-C(13)	1.386 (7)
C(9)-C(10)	1.381 (8)
C(10)-C(11)	1.385 (8)
C(11)-C(12)	1.373 (8)

Table 11 (continued).

Atom	Distance (Å)
C(12)-C(13)	1.388 (7)
C(14)-C(15)	1.391 (7)
C(14)-C(19)	1.399 (7)
C(15)-C(16)	1.377 (7)
C(16)-C(17)	1.389 (7)
C(17)-C(18)	1.384 (8)
C(18)-C(19)	1.384 (7)
C(20)-C(25)	1.392 (7)
C(20)-C(21)	1.402 (7)

C(21)-C(22)	1.379 (7)
C(22)-C(23)	1.370 (8)
C(23)-C(24)	1.384 (8)
C(24)-C(25)	1.385 (7)
C(26)-C(27)	1.373 (7)
C(26)-C(31)	1.383 (7)
C(27)-C(28)	1.398 (8)
C(28)-C(29)	1.382 (8)
C(29)-C(30)	1.369 (8)
C(30)-C(31)	1.384 (8)
C(32)-C(37)	1.393 (7)
C(32)-C(33)	1.401 (7)
C(33)-C(34)	1.387 (8)
C(34)-C(35)	1.369 (9)
C(35)-C(36)	1.373 (8)
C(36)-C(37)	1.393 (8)
C(38)-C(43)	1.385 (8)

Table 11 (continued).

Atom	Distance (Å)
C(38)-C(39)	1.387 (7)
C(39)-C(40)	1.399 (8)
C(40)-C(41)	1.388 (9)
C(41)-C(42)	1.358 (9)
C(42)-C(43)	1.381 (8)
Molecule 2	
Cu(1)-P(1)	2.2876 (15)
Cu(1)-P(2)	2.2974 (16)

Cu(1)-S(1)	2.3942 (15)
Cu(1)-I(1)	2.6534 (8)
S(1)-C(1)	1.718 (5)
N(1)-C(1)	1.328 (6)
N(2)-C(1)	1.324 (6)
N(2)-C(2)	1.434 (6)
P(1)-C(20)	1.821 (5)
P(1)-C(14)	1.824 (6)
P(1)-C(8)	1.827 (5)
P(2)-C(32)	1.830 (5)
P(2)-C(26)	1.833 (5)
P(2)-C(38)	1.834 (5)
C(2)-C(3)	1.371 (7)
C(2)-C(7)	1.382 (7)
C(3)-C(4)	1.391 (7)
C(4)-C(5)	1.381 (8)
C(5)-C(6)	1.380 (8)
C(6)-C(7)	1.402 (7)

Table 11 (continued).

Atom	Distance (Å)
C(8)-C(9)	1.376 (7)
C(8)-C(13)	1.383 (7)
C(9)-C(10)	1.382 (8)
C(10)-C(11)	1.360 (8)
C(11)-C(12)	1.363 (9)
C(12)-C(13)	1.386 (8)
C(14)-C(15)	1.393 (7)

C(14)-C(19)	1.407 (7)
C(15)-C(16)	1.382 (7)
C(15)-C(17)	1.374 (7)
C(17)-C(18)	1.376 (8)
C(18)-C(19)	1.381 (7)
C(20)-C(21)	1.388 (7)
C(20)-C(25)	1.395 (7)
C(21)-C(22)	1.387 (7)
C(22)-C(23)	1.383 (8)
C(23)-C(24)	1.380 (7)
C(24)-C(25)	1.377 (7)
C(26)-C(31)	1.392 (7)
C(26)-C(27)	1.401 (7)
C(27)-C(28)	1.381 (8)
C(28)-C(29)	1.383 (8)
C(29)-C(30)	1.387 (8)
C(30)-C(31)	1.388 (7)
C(32)-C(33)	1.396 (7)
C(32)-C(37)	1.398 (7)

Table 11 (continued).

Atom	Distance (Å)
C(33)-C(34)	1.396 (8)
C(34)-C(35)	1.361 (8)
C(35)-C(36)	1.373 (9)
C(36)-C(37)	1.383 (8)
C(38)-C(39)	1.384 (7)
C(38)-C(43)	1.395 (7)

C(39)-C(40)	1.398 (7)
C(40)-C(41)	1.368 (8)
C(41)-C(42)	1.374 (8)
C(42)-C(43)	1.399 (7)

Table 12 Non - hydrogen inerbond angles of [CuI(PPh₃)₂(ptu)].

Atom	Angle (°)
Molecule 1	
P(1)-Cu(1)-P(2)	118.63 (5)
P(1)-Cu(1)S(1)	104.71 (6)
P(2)Cu(1)S(1)	111.08 (6)
P(1)-Cu(1)-I(1)	110.24 (4)
P(2)-Cu(1)-I(1)	100.32 (4)
S(1)-Cu(1)-I(1)	112.06 (4)
C(1)-S(1)-Cu(1)	111.92 (19)
C(1)-N(2)-C(2)	130.9 (5)
C(20)-P(1)-C(14)	103.9 (2)
C(20)-P(1)-C(8)	99.8 (2)
C(14)-P(1)-C(8)	104.6 (2)
C(20)-P(1)-Cu(1)	117.67 (19)
C(14)-P(1)-Cu(1)	110.39 (17)
C(8)-P(1)-Cu(1)	118.67 (17)
C(32)-P(2)-C(26)	102.7 (2)
C(32)-P(2)-C(38)	105.0 (3)
C(26)-P(2)-C(38)	101.0 (2)
C(32)-P(2)-Cu(1)	111.06 (17)
C(26)-P(2)-Cu(1)	117.76 (19)
C(38)-P(2)-Cu(1)	117.57 (18)
N(1)-C(1)-N(2)	119.0 (5)
N(1)-C(1)-S(1)	121.2 (4)
N(2)-C(1)-S(1)	119.8 (4)
C(3)-C(2)-C(7)	121.0 (5)
C(3)-C(2)-N(2)	116.3 (5)

Table 12 (continued).

Atom	Angle (°)
C(7)-C(2)-N(2)	122.4 (5)
C(2)-C(3)-C(4)	119.1 (5)
C(5)-C(4)-C(3)	121.1 (6)
C(6)-C(5)-C(4)	119.2 (5)
C(5)-C(6)-C(7)	121.9 (6)
C(6)-C(7)-C(2)	117.7 (6)
C(9)-C(8)-C(13)	119.0 (5)
C(9)-C(8)-P(1)	117.8 (4)
C(13)-C(8)-P(1)	122.9 (4)
C(10)-C(9)-C(8)	120.8 (6)
C(9)-C(10)-C(11)	120.4 (6)
C(12)-C(11)-C(10)	118.7 (6)
C(11)-C(12)-C(13)	121.5 (6)
C(8)-C(13)-C(12)	119.6 (5)
C(15)-C(14)-C(19)	118.1 (5)
C(15)-C(14)-P(1)	120.0 (4)
C(19)-C(14)-P(1)	121.5 (4)
C(16)-C(15)-C(14)	121.0 (5)
C(15)-C(16)-C(17)	120.3 (5)
C(18)-C(17)-C(16)	119.7 (5)
C(17)-C(18)-C(19)	119.9 (5)
C(18)-C(19)-C(14)	121.0 (5)
C(25)-C(20)-C(21)	118.2 (5)
C(25)-C(20)-P(1)	120.0 (4)
C(21)-C(20)-P(1)	121.7 (4)

C(22)-C(21)-C(20) 120.1 (5)

Table 12 (continued).

Atom	Angle (°)
C(23)-C(22)-C(21)	121.2 (5)
C(22)-C(23)-C(24)	119.6 (5)
C(23)-C(24)-C(25)	119.9 (6)
C(24)-C(25)-C(20)	121.0 (5)
C(27)-C(26)-C(31)	119.1 (5)
C(27)-C(26)-P(2)	119.0 (4)
C(31)-C(26)-P(2)	121.7 (4)
C(26)-C(27)-C(28)	120.9 (6)
C(29)-C(28)-C(27)	119.2 (6)
C(30)-C(29)-C(28)	120.1 (6)
C(29)-C(30)-C(31)	120.4 (6)
C(26)-C(31)-C(30)	120.4 (5)
C(37)-C(32)-C(33)	117.9 (5)
C(37)-C(32)-P(2)	121.1 (4)
C(33)-C(32)-P(2)	120.7 (4)
C(34)-C(33)-C(32)	120.2 (6)
C(35)-C(34)-C(33)	120.9 (6)
C(34)-C(35)-C(36)	120.2 (6)
C(35)-C(36)-C(37)	119.6 (6)
C(32)-C(37)-C(36)	121.2 (5)
C(43)-C(38)-C(39)	118.9 (5)
C(43)-C(38)-P(2)	116.9 (4)
C(39)-C(38)-P(2)	124.0 (4)
C(38)-C(39)-C(40)	118.7 (6)

C(41)-C(40)-C(39)	121.5 (6)
C(42)-C(41)-C(40)	119.0 (6)

Table 12 (continued).

Atom	Angle (°)
C(41)-C(42)-C(43)	120.3 (7)
C(42)-C(43)-C(38)	121.6 (6)
Molecule 2	
P(1)-Cu(1)-P(2)	122.18 (5)
P(1)-Cu(1)-S(1)	101.63 (5)
P(2)-Cu(1)-S(1)	109.15 (5)
P(1)-Cu(1)-I(1)	104.23 (4)
P(2)-Cu(1)-I(1)	109.85 (4)
S(1)-Cu(1)-I(1)	109.05 (4)
C(1)-S(1)-Cu(1)	112.02 (19)
C(1)-N(2)-C(2)	128.0 (4)
C(20)-P(1)-C(14)	103.9 (2)
C(20)-P(1)-C(8)	99.8 (2)
C(14)-P(1)-C(8)	104.6 (2)
C(20)-P(1)-Cu(1)	117.67 (19)
C(14)-P(1)-Cu(1)	110.39 (17)
C(8)-P(1)-Cu(1)	118.67 (17)
C(32)-P(2)-C(26)	102.7 (2)
C(32)-P(2)-C(38)	105.0 (3)
C(26)-P(2)-C(38)	101.0 (2)
C(32)-P(2)-Cu(1)	111.06 (17)
C(26)-P(2)-Cu(1)	117.76 (19)
C(38)-P(2)-Cu(1)	117.57 (18)

C(20)-P(1)-C(9)	102.3 (2)
C(20)-P(1)-C(14)	104.5 (2)
C(9)-P(1)-C(14)	104.1 (2)

Table 12 (continued).

Atom	Angle (°)
C(20)-P(1)-Cu(1)	115.18 (17)
C(8)-P(1)-Cu(1)	115.14 (17)
C(14)-P(1)-Cu(1)	114.08 (17)
C(32)-P(2)-C(26)	105.1 (2)
C(32)-P(2)-C(38)	97.9 (2)
C(26)-P(2)-C(38)	105.0 (2)
C(32)-P(2)-Cu(1)	118.66 (19)
C(26)-P(2)-Cu(1)	111.57 (17)
C(38)-P(2)-Cu(1)	116.81 (17)
N(1)-C(1)-N(1)	119.9 (5)
N(1)-C(1)-S(1)	120.4 (4)
N(2)-C(1)-S(1)	119.7 (4)
C(3)-C(2)-C(7)	120.6 (5)
C(3)-C(2)-N(2)	118.2 (5)
C(7)-C(2)-N(2)	121.0 (5)
C(2)-C(3)-C(4)	120.2 (5)
C(5)-C(4)-C(3)	119.9 (6)
C(6)-C(5)-C(4)	119.9 (5)
C(5)-C(6)-C(7)	120.3 (5)
C(2)-C(7)-C(6)	119.1 (5)
C(9)-C(8)-C(13)	117.1 (5)
C(9)-C(8)-P(1)	118.1 (4)

C(13)-C(8)-P(1)	124.8 (4)
C(8)-C(9)-C(10)	121.5 (6)
C(9)-C(10)-C(11)	119.1 (6)
C(10)-C(11)-C(12)	120.6 (6)

Table 12 (continued).

Atom	Angle (°)
C(8)-C(13)-C(12)	121.0 (6)
C(15)-C(14)-C(19)	118.1 (5)
C(15)-C(14)-P(1)	118.2 (4)
C(19)-C(14)-P(1)	123.6 (4)
C(16)-C(15)-C(14)	120.8 (5)
C(15)-C(16)-C(17)	120.5 (6)
C(18)-C(17)-C(16)	119.5 (6)
C(17)-C(18)-C(19)	121.0 (5)
C(18)-C(19)-C(14)	120.0 (5)
C(25)-C(20)-C(21)	118.7 (5)
C(21)-C(20)-P(1)	123.5 (4)
C(25)-C(20)-P(1)	117.7 (4)
C(22)-C(21)-C(20)	120.2 (5)
C(23)-C(22)-C(21)	120.1 (5)
C(22)-C(23)-C(24)	120.3 (5)
C(23)-C(24)-C(25)	119.5 (5)
C(24)-C(25)-C(20)	121.2 (5)
C(27)-C(26)-C(31)	118.2 (5)
C(31)-C(26)-P(2)	118.2 (4)
C(27)-C(26)-P(2)	123.1 (4)
C(26)-C(27)-C(28)	120.4 (5)

C(29)-C(28)-C(27)	120.9 (5)
C(30)-C(29)-C(28)	119.4 (5)
C(29)-C(30)-C(31)	119.9 (5)
C(26)-C(31)-C(30)	121.2 (5)
C(37)-C(32)-C(33)	118.3 (5)

Table 12 (continued).

Atom	Angle (°)
C(33)-C(32)-P(2)	119.9 (4)
C(37)-C(32)-P(2)	121.6 (4)
C(34)-C(33)-C(32)	119.7 (6)
C(35)-C(34)-C(33)	120.8 (6)
C(34)-C(35)-C(36)	120.3 (6)
C(35)-C(36)-C(37)	120.1 (6)
C(32)-C(37)-C(36)	120.8 (6)
C(43)-C(38)-C(39)	119.1 (5)
C(39)-C(38)-P(2)	124.6 (4)
C(43)-C(38)-P(2)	116.1 (4)
C(38)-C(39)-C(40)	119.8 (5)
C(41)-C(40)-C(39)	120.8 (5)
C(42)-C(41)-C(40)	120.3 (5)
C(41)-C(42)-C(43)	119.6 (5)
C(42)-C(43)-C(38)	120.4 (5)
C(10)-C(44)-C(9)	120.5 (6)

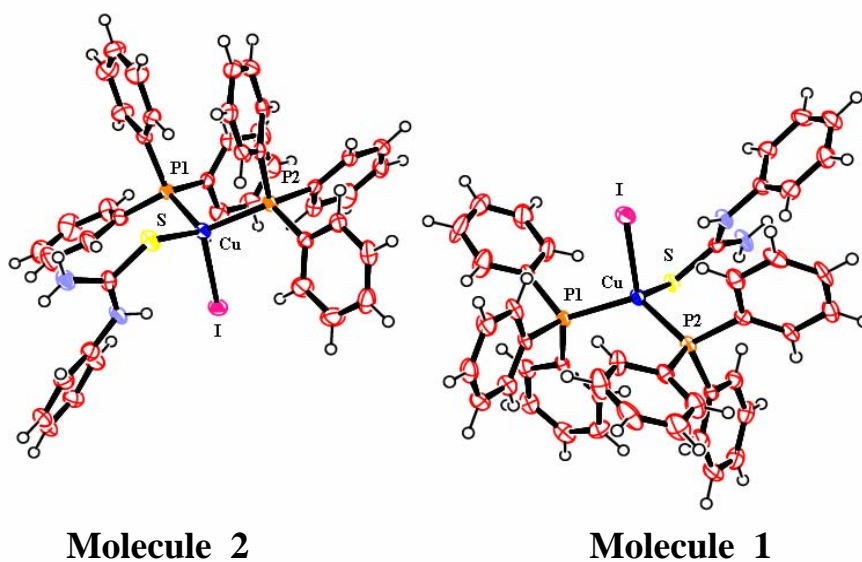

Figure 56 The structure of [CuI(PPh₃)₂(ptu)]. Ellipsoids are drawn at the 50 % probability level.

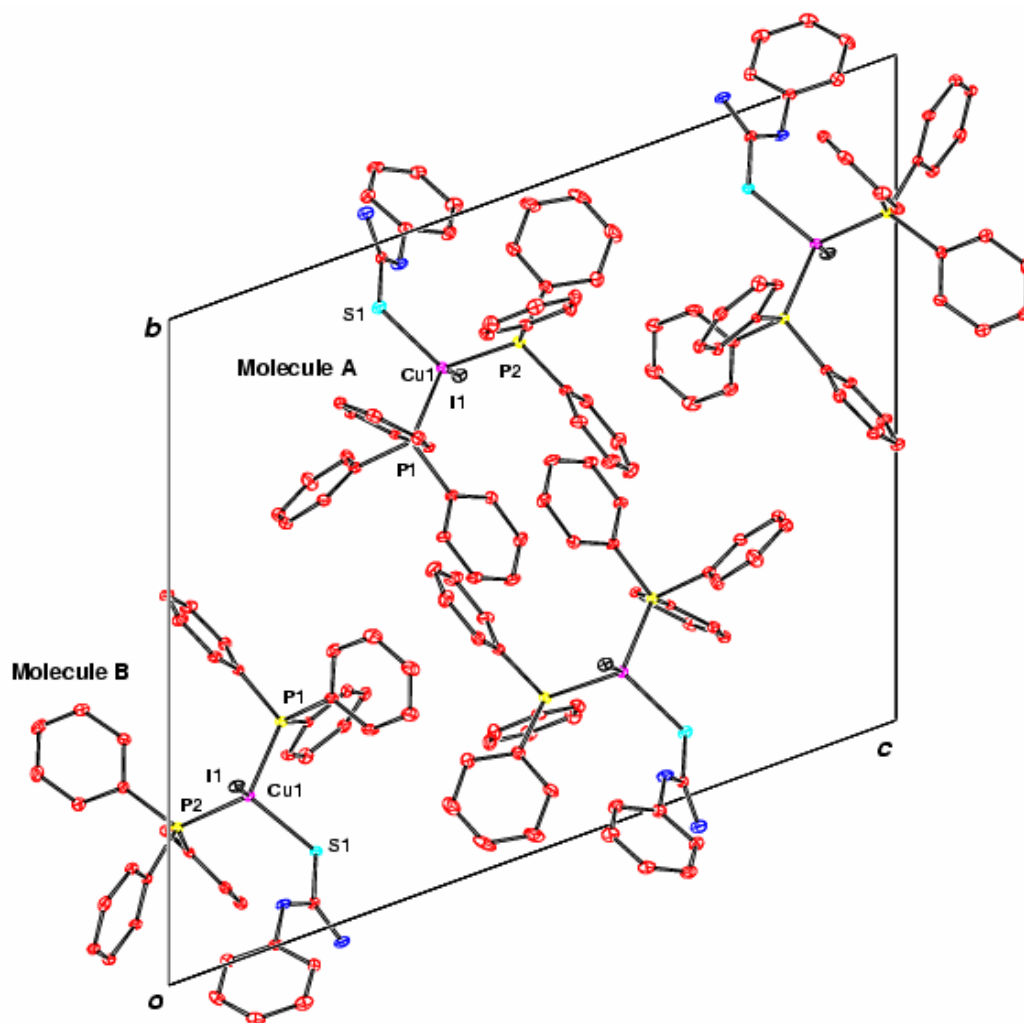

Figure 57 Unit cell contents of $[\text{CuI}(\text{PPh}_3)_2(\text{ptu})]$ projected down a . The hydrogen atoms are omitted for clarity.

CHAPTER 4

Discussion

4.1 Preparation of complexes

The complexes were prepared by reacting copper (I) halide (CuX, X= Cl, Br, I) and triphenylphosphine (PPh₃), followed by the addition of *N*-phenylthiourea (ptu) in optimum solution. This procedure, frequently used for the preparation of copper(I) halide complexes containing both thioamide and triphenylphosphine ligands, gave monomeric complexes of the formula [CuX(PPh₃)₂(ptu)] in which the structures determined by single crystal X-ray diffraction method. However, the complexes, which were studied, must be single crystals, then, preparations condition of complexes and crystallization must be significant. During the preparation stage it is noticed that the reaction between copper salt and mixed ligand of triphenylphosphine and *N*-phenylthiourea is capable of producing a variety of products whose composition is dependent on the nature of solvent, the coordinating properties of the counterion. As well as the molar ratios of the reactants and the reaction time employed. However in this research most mole ratio of CuX (X=Cl, Br and I) with ptu and PPh₃, which gave complexes, are 1:1:3, 1:1.5:2.5 and 1:2:3 respectively. In addition, the formation of the above mixed-ligand complexes was related to the reaction temperature, so that the desired product was only obtained when the temperature was in the range of 70-75°C and crystallization of these complexes was obtained by slow evaporation.

All the complexes are colorless solids which are soluble in acetone, acetonitrile, chloroform, dibromomethane and DMSO. They are however, insoluble in water and ether.

4.2 Elemental Analysis

The method to determine the content of carbon, hydrogen, nitrogen and sulfur in complexes by CHN Elemental Analyzer is reported. The experimental (%) values

are given in Table 4 in which they are in close agreement with the corresponding theoretical values and the experimental data are slightly different from the theoretical data because of the impurity, the moisture and how sensitive of samples to the air.

4.3 X-ray Fluorescence Spectrometry

This method is widely used to measure the elemental composition of materials. Since this method is fast and non-destructive to the sample. It is the method of choice for field applications and industrial production for control of materials.

From XRF spectra of $[\text{CuCl}(\text{PPh}_3)_2(\text{ptu})]$, $[\text{CuBr}(\text{PPh}_3)_2(\text{ptu})]$ and $[\text{CuI}(\text{PPh}_3)_2(\text{ptu})]$ complexes which the $K\alpha$ spectrum of Cu, Cl, Br and I appears at 8.04, 2.62, 11.92 and 28.65 keV, respectively, represented for copper(I) salts. In addition, S and P atoms are represented for ptu and PPh_3 , respectively in which the $K\alpha$ spectrum appears at 2.32 and 2.01 keV for S and P, respectively. The XRF spectra of all complexes are shown in Figures 30-38.

4.4 Infrared Spectroscopy

Infrared (IR) spectroscopy is one of the most common spectroscopic techniques used by organic and inorganic chemists. Simply, it is the absorption measurement of different IR frequencies by a sample positioned in the path of an IR beam. The main goal of IR spectroscopic analysis is to determine the chemical functional groups in the sample. Different functional groups absorb characteristic frequencies of IR radiation. Using various sampling accessories, IR spectrometers can accept a wide range of sample types such as gases, liquids, and solids. Thus, IR spectroscopy is an important and popular tool for structural elucidation and compound identification.

Because of *N*-phenylthiourea (ptu) ligand consists of the $\text{NHC}=\text{S}$ group as shown Figure 3 in which it may be adopted either the thione form ($\text{H}-\text{N}-\text{C}=\text{S}$) or the thiol form ($\text{N}=\text{C}-\text{S}-\text{H}$)

However, sulfur or nitrogen atom of ptu ligand can coordinate with copper (I) atom. From the previous study found that IR spectra exhibit the dominance of the

thione form of the ligands investigated deduced by the presence of $\nu(\text{N-H})$ bands at $3200\text{-}3130\text{ cm}^{-1}$, the absence of any evidence for $\nu(\text{S-H})$ bands in the $2500\text{-}2600\text{ cm}^{-1}$ region and the production of characteristic “thioamide band” as well as the characteristic medium $\nu(\text{Cu-S})$ bands at $370\text{-}340\text{ cm}^{-1}$ (Hadjikakov *et al.*, 1999).

The previous studies of infrared absorption spectra for thioamide complexes have been assigned as follows:

Yamaguchi (Yamaguchi *et al.*, 1958) assigned the infrared absorption bands for metal thiourea complexes. This investigation was undertaken to assign the infrared absorption bands for metal thiourea complexes based on the normal vibration calculation of the thiourea molecule.

Bands	Region	Assignment
I	3350 cm^{-1}	$\nu(\text{N-H})$
II	1600 cm^{-1}	$\delta(\text{NH}_2)$
III	1500 cm^{-1}	$\nu_s(\text{C-N})$
IV	1100 cm^{-1}	$\nu(\text{C-S})$
V	700 cm^{-1}	$\nu_s(\text{C-N}) + \nu(\text{C=S})$

Karagiannidis (Karagiannidis *et al.*, 1989) studied structures and infrared spectra of Cu(I) complexes with heterocyclic thiones and triphenylphosphine as ligands.

Bands	Region	Assignment
I	2900 cm^{-1}	$\nu(\text{N-H})$
II	1510 cm^{-1}	$\delta(\text{NH}_2)$
III	1320 cm^{-1}	$\nu(\text{C=N}) + \nu(\text{C-N}) + \nu(\text{C=S})$
IV	1000 cm^{-1}	$\nu(\text{C=S}) + \nu(\text{C-N})$
V	750 cm^{-1}	$\nu(\text{C=S})$

Lecomte (Lecomte *et al.*, 1989) studied structures and infrared spectra of Cu(I) bromide complexes with heterocyclic thiones and triphenylphosphine as ligands.

Bands	Region	Assignment
I	3180-3130 cm ⁻¹	ν (N-H)
II	1505-1515 cm ⁻¹	δ (NH ₂)
III	1330-1250 cm ⁻¹	ν (C=N) + ν (C-N) + ν (C=S)
IV	1030-990 cm ⁻¹	ν (C=S) + ν (C-N)
V	900 cm ⁻¹	ν (C=S)

The N-H stretching frequency in the complexes tends to lie at a lower wavenumber than in the free ligand, but the shifts of this band are small, suggesting that the nitrogen atoms are not involved in bonding.

Singh (Singh and Dikshit, 1995) studied the infrared spectra for the mixed ligand copper(I) halide complexes between triphenylarsine and *N,N*-dimethyl-*N'*-phenylthiourea (dmptu), *N,N*-dibutyl-*N'*-phenylthiourea (dbptu) or 1,3-thiazolidine-2-thione (tzdtH).

Bands	Region	Assignment
I	1510 cm ⁻¹	ν (C-N) + δ (N-H)
II	1320 cm ⁻¹	ν (C=S) + ν (C=N) + ν (C-H)
III	1000 cm ⁻¹	ν (C-N) + ν (C-S)
IV	800 cm ⁻¹	ν (C-S)

The thioamide bands III is too weak to be observed. The thioamide bands II and III have contributions from ν (C=S) and ν (C=N) vibrations but ν (C=S) contributes more than ν (C=N) to the thioamide band II. Therefore band II can be utilized to decide the coordination site.

To support the crystal structures of these complexes, the 6 bands are considered as follows; ν (N-H), ν (C-N) and four thioamide bands (I- IV) at about 1500 (ν (C-N) + δ (N-H)), 1330 (ν (C=S) + ν (C=N) + ν (C-N)), 1030 (ν (C-N) + ν (C-S)) and 745 (ν (C-S)) (Cox *et al.*, 1999).

IR Spectroscopy of free ligands and its complexes

The major IR bands of ptu and its complexes in this study are summarized in Table 13.

Table 13 Major IR bands of ptu and its complexes (cm^{-1}).

Compound	$\nu(\text{N-H})$	$\nu(\text{C-N})$	Band			
			I	II	III	IV
ptu ligand	3425	1445	1520	1325	1060	810
	3280		1300			
	3182		1295			
	3001		1230			
1. $[\text{CuCl}(\text{PPh}_3)_2(\text{ptu})]$	3420	1448	1589	1318	1061	-
	3240		1286			
	3138		1249			
	3000					
2. $[\text{CuBr}(\text{PPh}_3)_2(\text{ptu})]$	3421	1456	1585	1338	1093	-
	3272		1320			
	3179		1284			
3. $[\text{CuI}(\text{PPh}_3)_2(\text{ptu})]$	3431	1480	1571	1322	1092	-
	3391		1298			
	3284		1267			
	3142		1241			

In the spectra of the complexes, the N-H stretching frequency of [CuCl(PPh₃)₂(ptu)] and [CuBr(PPh₃)₂(ptu)] appear at the lower frequencies than free ligand. The red shift of the $\nu(\text{N-H})$ bands are usually regarded as signifying that the ligand is non N-bonded to the metal. However, the N-H stretching of [CuI(PPh₃)₂(ptu)] appears at the higher frequencies than the free ligand is probably due to the hydrogen bonding in the complexes. (N-H---X) (X = I).

The band of complexes 1, 2 and 3 exhibits C-N stretching vibration at 1448, 1456, 1480 cm⁻¹, respectively. These values are blue shifted by about 3-35 cm⁻¹ compared with free ptu ligand at 1445 cm⁻¹. The result can be explained as the increasing double bond character of C-N in complexes.

However, the analysis of the thioamide bands has used in the past to differentiate between M-N and M-S contacts for various thione ligands (Karagiannidis *et al.*, 1990). The band observed at the region 1571-1589 cm⁻¹ can be explained as thioamide band I. There are slightly increased about 49-69 cm⁻¹ in all complexes. The increasing frequency of complexes, can be described as the hydrogen bond interactions in crystal packing of the complexes.

The thioamide band II found at the region 1338-1241 cm⁻¹ which can be explained as C=S stretching and C=N stretching vibration but C=S stretching contributes more than C=N stretching. The shift of these bands at higher frequency in spectra of complexes, suggest the decrease of double bond character in carbon-to-sulfur and the increase of double bond character in carbon-to-nitrogen bond.

The thioamide band III of complexes 1, 2 and 3, observed at 1061, 1093 and 1092 cm⁻¹, respectively. The spectra show a shift to higher wave number (ligand ptu observed at 1060 cm⁻¹). The shifts of these bands due to the C-N stretching plus C-S stretching, however, C-S stretching dominates more than C-N stretching (upward shift of 30 cm⁻¹). This observation can be explained by the considerable change in nature of the N-C bond and the C=S bond on coordination of ligand through the sulfur atom. The contribution of the $\nu(\text{C=S})$ band is decreased and the intensity of this band reduced.

Finally, the thioamide band IV of ligand ptu found at 810 cm⁻¹, attributed to C-S stretching. But at the present of complexes 1, 2 and 3 they are partly masked by

strong triphenylphosphine absorptions and therefore diagnostically useless (Karagiannidis *et al.*,1990).

The infrared spectra of triphenylphosphine have four interesting regions.

Band	Region	Assignment
I	3066 cm ⁻¹	$\nu(\text{C-H})$
II	1582 and 1475 cm ⁻¹	$\nu(\text{C=C})$
III	1090 cm ⁻¹	$\delta(\text{C-H})$ inplane
IV	748 and 695 cm ⁻¹	$\delta(\text{C-H})$ outplane

For The bands of complexes 1, 2 and 3 show distinct strong vibrational phosphine in which the bands remain practically unshift upon coordination.

4.5 ¹H NMR and ¹³C NMR Spectroscopy

The ¹H NMR spectra of the compounds in DMSO-*d*₆ solution at ambient temperature (Table 14) clearly show the signal expected for the phosphine and thione ligands (Figure 47-51), and also provided proof that ligands are (NH)-protonated. The presence of a single resonance at δ 9-14 ppm (sometimes very broad), together with the absence of any evidence for the thiol (SH)-proton (at δ = 3-5 ppm), indicate the thione tautomer as the dominant species in the complexes studied. (Karagiannidis *et al.*, 1990)

The broadening of the signal may be due to hydrogen bonding. The fine resolution ¹H NMR spectra at different concentrations in the NH region shows almost slightly of the NH proton signal which indicates the NH hydrogens are intramolecularly bonded to the halides. The gradual decrease in intramolecular hydrogen bonding strength is reflected by corresponding lowering of δ values for NH proton on going from chloride to bromide to iodide complexes. On complexation the ¹H NMR signals of CH₂-group shift slightly towards the higher magnetic field (lower δ value). The proportions of the protons, observed by integration, are exactly matching with the proposed stoichiometry of the complexes. (Singh *et al.*,1995)

Table 14 ^1H NMR spectra data of the ligand ptu and complexes in $\text{DMSO-}d_6$.

Compound	^1H NMR signal with assignment [ppm(δ)]
Ligand ptu	9.68 (<i>s</i> , 1H > NH group) 7.08-7.39 (<i>m</i> , 5H > C ₆ H ₅ group)
1. [CuCl(PPh ₃) ₂ (ptu)]	10.28 (<i>s</i> , 1H > NH group) 7.17-7.40 (<i>m</i> , 35H > C ₆ H ₅ groups)
2. [CuBr(PPh ₃) ₂ (ptu)]	10.18(<i>s</i> , 1H > NH group) 7.18-7.40 (<i>m</i> , 35H > C ₆ H ₅ groups)
3. [CuI(PPh ₃) ₂ (ptu)]	10.01(<i>s</i> , 1H > NH group) 7.18-7.39 (<i>m</i> , 35H > C ₆ H ₅ groups)

The ^{13}C NMR spectra of complexes are diagnostically of minor importance, since the carbons of *N*-phenylthiourea, which consists of C=S.

The ^{13}C NMR chemical shifts for the C=S carbon of ptu in all complexes are given in Table 15. Only small changes were observed in the coupling constant on complexation with copper(I). An upfield shift (about 4 ppm) is observed in the C=S resonance of ptu on its complexation with copper(I). The upfield shift is attributed to lowering of C=S bond order upon coordination and a shift of N→C electron density producing a partial double bond character in the C-N bond.

Table 15 ^{13}C NMR spectra data of the ligand ptu and complexes.

Compound	$\delta \text{ C} = \text{S}$ (ppm)
ptu	181.16
$[\text{CuCl}(\text{PPh}_3)_2(\text{ptu})]$	178.41
$[\text{CuBr}(\text{PPh}_3)_2(\text{ptu})]$	177.73
$[\text{CuI}(\text{PPh}_3)_2(\text{ptu})]$	177.60

4.6 X-ray Structure Determination

The X-ray diffraction analyses for complexes $[\text{CuCl}(\text{PPh}_3)_2(\text{ptu})]$ and $[\text{CuBr}(\text{PPh}_3)_2(\text{ptu})]$ were performed at room temperature on SMART CCD diffractometer whereas complex $[\text{CuI}(\text{PPh}_3)_2(\text{ptu})]$ was performed at low temperature on Bruker-AXS Platform diffractometer with graphite monochromated MoK_α radiation ($\lambda = 0.71074$). The structures were solved and refined by using Xtal program system.

4.6.1 The structure of $[\text{CuCl}(\text{PPh}_3)_2(\text{ptu})]$ (1) and $[\text{CuBr}(\text{PPh}_3)_2(\text{ptu})]$ (2)

The complex (1) is isomorphous and isostructural with complex (2), both complexes crystallize in the triclinic space group $P\bar{1}$ and $Z = 2$ with cell parameters $a = 10.5226(1)$, $b = 11.3035(2)$, $c = 17.1848(2)$ Å, $\alpha = 97.605(1)$, $\beta = 103.508(1)$, $\gamma = 103.605(1)^\circ$ and $a = 10.6236(4)$, $b = 11.2135(4)$, $c = 17.1481(7)$ Å, $\alpha = 97.957(1)$, $\beta =$

102.424(1), $\gamma = 102.994(1)^\circ$ for complex (1) and complex (2) respectively. Each of these structures features a distorted tetrahedral copper(I) center with two phosphorus atoms of two triphenylphosphine molecules, one sulfur atom of phenylthiourea molecule and one chloride or bromide atom (Figure 58). In both complexes described here, angular deviations from the ideal tetrahedral value of 109.4° are small when compared with several reported, four coordinated, copper(I) halide complexes bearing a heterocyclic thioamide and two monodentate phosphine. In fact, the P(1)-Cu(1)-P(2) angle, with a value of $120.67(2)^\circ$ and $120.92(3)^\circ$ in complex (1) and complex (2), respectively compare with the previously observed values in a series of analogous complexes, e.g. in $[\text{Cu}(\text{PPh}_3)_2(\text{tzdtH})\text{Cl}]$ (P-Cu-P = $122.41(11)^\circ$) (Aslanidis *et al.*, 1998) and in $[\text{Cu}(\text{PPh}_3)_2(\text{py}2\text{SH})\text{Br}]$ (P-Cu-P = $125.0(2)^\circ$) (Karagiannidis *et al.*, 1998). A possible explanation for the large value is the steric interaction between the PPh_3 groups. This higher angle is counter balanced by the bond angles X-Cu-S, X-Cu-P(2) and S-Cu-P(1), X; Cl and Br, whose values are lower than 109.4° .

The observed Cu-S distances of 2.4722(6) and 2.4387(8) Å in complex (1) and complex (2), respectively, are consistent with the distances usually found for tetrahedrally coordinated copper(I) with thione-sulfur donors.

In both structures, the Cu-P(1) and Cu-P(2) distances of 2.2941(6) and 2.3208(6) Å in complex (1) and 2.2936(8) and 2.3173(8) Å in complex (2) are within the limits of the range expected for tetrahedrally coordinated copper(I), which are in good agreement with previous values obtained for Cu-P bonds of $[\text{Cu}(\text{PPh}_3)_3\text{Cl}]$ complex (Bowmaker *et al.*, 1987). Nevertheless, the Cu-P distances of complexes (1) and (2) are significantly longer than those observed in the isomorphous structure of $[\text{Cu}(\text{PPh}_3)_2(\text{nbzimtH}_2)\text{Cl}]$ (2.278(1) and 2.295(1) Å) (Skoulika *et al.*, 1991) and $[\text{Cu}(\text{PPh}_3)_2(\text{meimtH})\text{Br}]$ (2.268(1) and 2.281(1) Å) (Karagiannidis *et al.*, 1990), but closer to those found in other triphenylphosphine complexes.

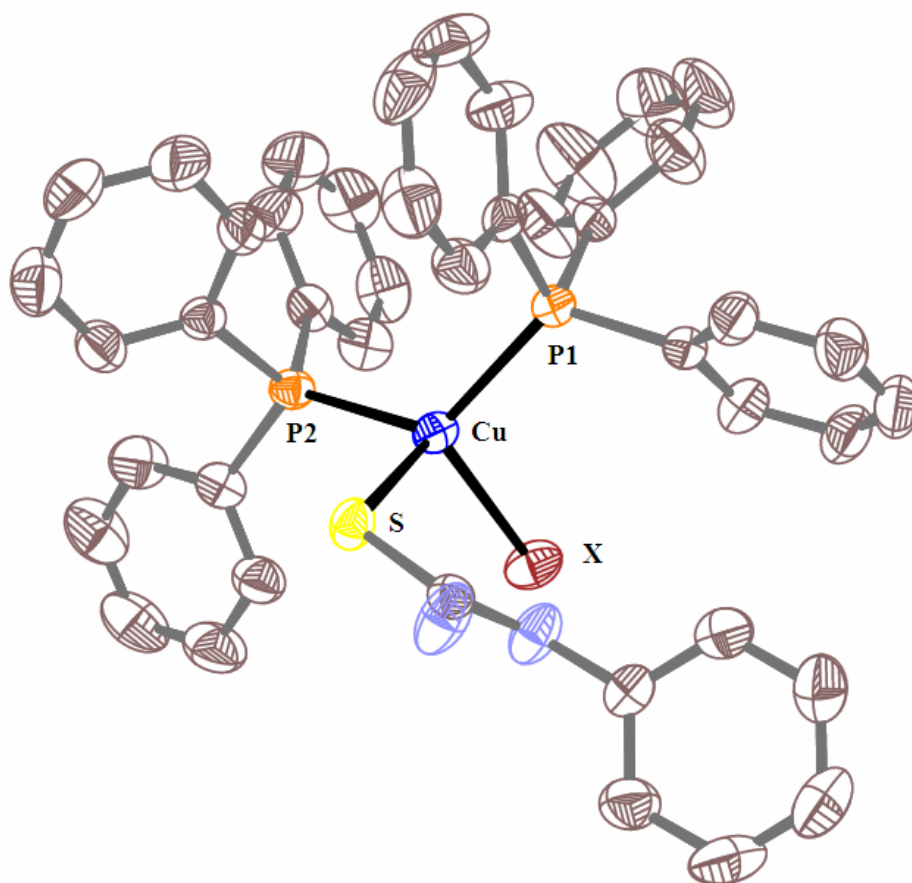

Figure 58 The molecular structure of $[\text{CuX}(\text{PPh}_3)_2(\text{ptu})]$ ($\text{X} = \text{Cl}$ and Br) complexes as a distorted tetrahedral.

4.6.2 The structure of $[\text{CuI}(\text{PPh}_3)_2(\text{ptu})]$ (3)

The complex (3), which crystallizes in the space group $P\bar{1}$ and $Z = 4$ with cell parameter $a = 10.9505(9)$, $b = 18.7294(15)$, $c = 21.3731(18)$ Å, $\alpha = 67.4220(10)$, $\beta = 77.2150(10)$, $\gamma = 73.2240(10)^\circ$. The structure of complex (3) is similar to the previous structures but this structure consists of two independent $[\text{CuI}(\text{PPh}_3)_2(\text{ptu})]$ molecules with above stoichiometry in asymmetric unit. The structures of the two molecules are very similar to the tetrahedral coordination of the copper(I) center in common in which copper is surrounded by the S donor of the phenylthiourea ligand, two P atoms of two phosphine ligands, as well as the corresponding iodide atom (Figure 59). The

irregularities in the tetrahedral coordination geometry about the copper(I) centre are best reflected in the values of the bond angles. This arrangement is considerably distorted since four angles around copper are deviated from those of a regular tetrahedron. The P(1)-Cu-P(2) angle deviates considerably from the tetrahedral value at 109.4° ($118.63(5)^\circ$ and $122.18(5)^\circ$ in molecule 1 and 2, respectively) (Table 17). Moreover the presence of intramolecular hydrogen bonds between the iodide and the N(1)H hydrogen [$N(2)\cdots I = 3.567(4) \text{ \AA}$, $H\cdots I = 2.71 \text{ \AA}$, $N(2)-H\cdots I = 164.5^\circ$] could be responsible for the moderate narrowing of the S-Cu-I angle ($109.05(4)^\circ$) in molecule 2 (Figure 60). It is noted that all these angles are in qualitative agreement with the corresponding values already observed for a series of monomeric copper(I) halide complexes that contain one heterocyclic thioamide and two triphenylphosphine ligands (Aslanidis *et al.*, 1993). The hydrogen-bonding geometry are shown in Table 17.

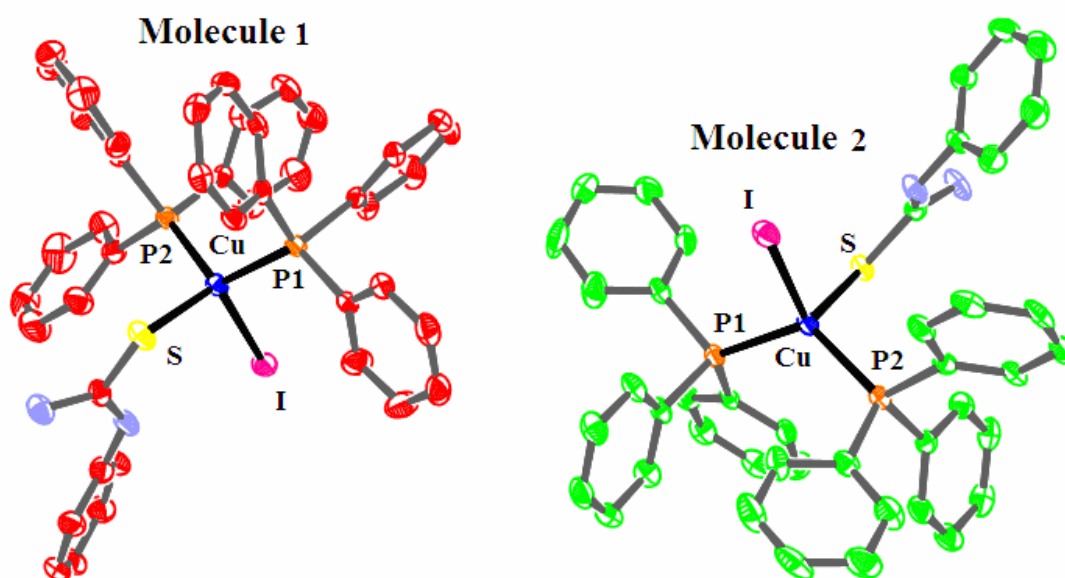

Figure 59 The molecular structure of $[\text{CuI}(\text{PPh}_3)_2(\text{ptu})]$ complexes. 50% Thermal ellipsoids are shown for the non-hydrogen atoms.

The most significant features of the present structure are the Cu-S and Cu-I bond lengths lie in the range normally observed for tetrahedrally coordinated copper(I) complexes with terminal iodide and thione-sulfur donors. The Cu-S and Cu-I distances are 2.4148(16), 2.3942(15) Å and 2.6658(8), 2.5334(8) Å in molecule 1 and 2, respectively (Table 18).

The Cu-P(1) and Cu-P(2) distances of 2.2908(15), 2.3024(16) Å and 2.2876(15), 2.2974(16) Å in molecule 1 and 2, respectively, are slightly shorter as compared to the value observed for [Cu(PPh₃)₃X] (Bowmaker *et al.*, 1987). Moreover, the planes of two aromatic rings of heterocyclic thioamide-ring (C(2)-C(7)) and phosphine-ring (C(38)-C(43)) of molecule 2 are almost perpendicular to one another (Figure 61).

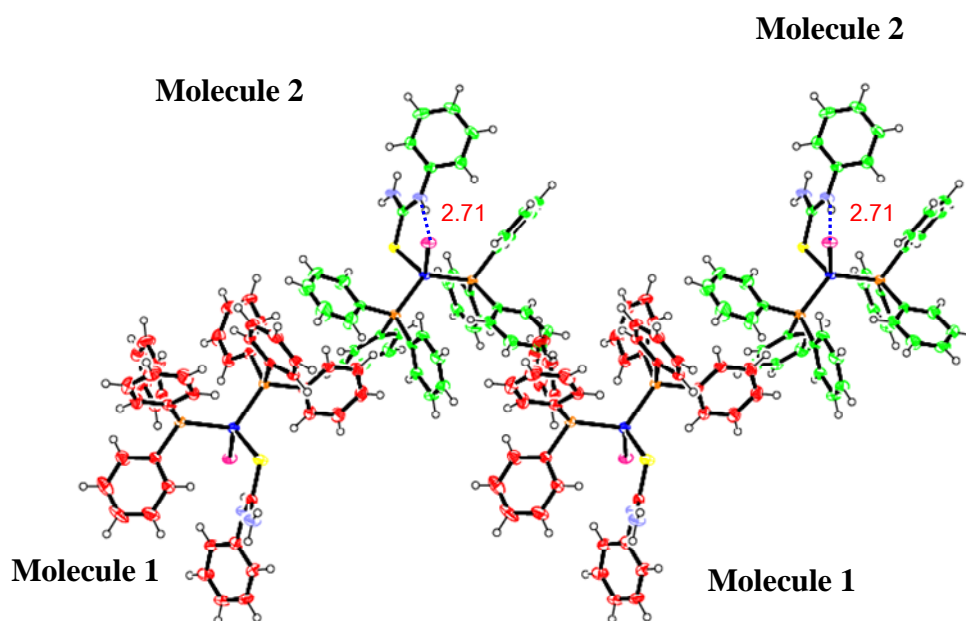
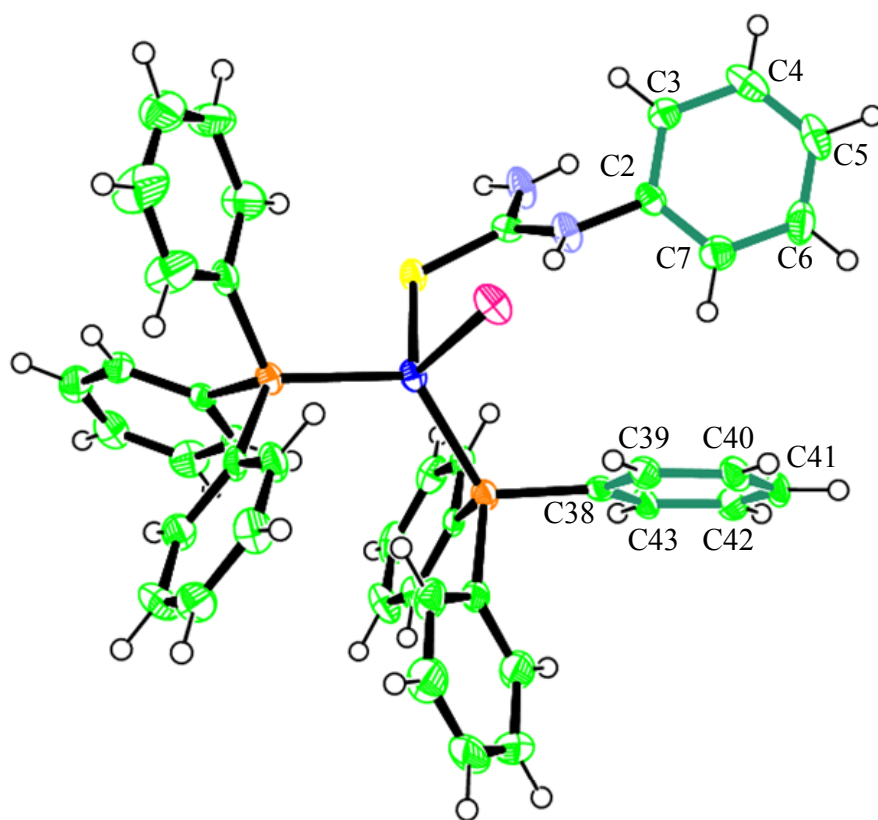

Figure 60 The intra-molecular hydrogen-bonding interaction of [CuI(PPh₃)₂(ptu)].



Molecule 2

Figure 61 The molecular structure of $[\text{Cu}(\text{PPh}_3)_2(\text{ptu})\text{I}]$ with atom labels for molecular structure 2.

Table 16 The selected bond lengths (Å) and angles (°) of the studied complexes.

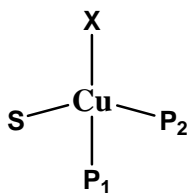

Complex Bond length/angle	[Cu(PPh₃)₂(ptu)Cl]	[Cu(PPh₃)₂(ptu)Br]	[Cu(PPh₃)₂(ptu)I]
Cu-X (Å)	2.3505(7)	2.4737(5)	2.6658(8) ^a 2.6534(8) ^b
Cu-S (Å)	2.4722(6)	2.4387(8)	2.4148(16) ^a 2.3942(15) ^b
Cu-P(1) (Å)	2.2941(6)	2.2936(8)	2.2908(15) ^a 2.2876(15) ^b
Cu-P(2) (Å)	2.3208(6)	2.3173(8)	2.3024(16) ^a 2.2974(16) ^b
P(1)-Cu-P(2) (°)	120.67(2)	120.92(3)	118.63(5) ^a 122.18(5) ^b
P(1)-Cu-S (°)	97.35(2)	98.57(3)	104.71(6) ^a 101.63(5) ^b
P(2)-Cu-S (°)	111.55(2)	111.66(3)	111.08(6) ^a 109.15(5) ^b

Complex Bond length/angle	[Cu(PPh₃)₂(ptu)Cl]	[Cu(PPh₃)₂(ptu)Br]	[Cu(PPh₃)₂(ptu)I]
P(1)-Cu-X (°)	114.80(2)	112.53(2)	110.24(4) ^a 104.23(4) ^b
P(2)-Cu-X (°)	108.14(2)	104.89(3)	100.32(4) ^a 109.85(4) ^b
S-Cu-X (°)	102.31(2)	104.89(3)	112.06(4) ^a 109.05(4) ^b

^a Molecule 1^b Molecule 2Table 17. Hydrogen bonds and angles for [CuI(PPh₃)₂(ptu)].

Hydrogen Bonds	<i>D</i> -H (Å)	H··· <i>A</i> (Å)	<i>D</i> ··· <i>A</i> (Å)	<i>D</i> -H··· <i>A</i> (°)
N(2)-H(2)···I	0.88	2.71	3.567(4)	164.5

D = Donor atom*A* = Acceptor atom

CHAPTER 5

Conclusion

The aim of this work is to study of the coordination capability of the rigid ligands, triphenylphosphine (PPh₃) and *N*-phenylthiourea (ptu) toward copper(I) halides. Continuing our investigations on the factors governing the stereochemical preferences of copper(I) compounds, we have found that PPh₃ readily forms complexes of composition [CuX(PPh₃)₃], probably of monomeric nature, that proves to be a good precursor for the preparation of other derivatives; in the course of the present study these are chosen for the synthesis of the series monomeric complexes, [CuX(PPh₃)₂(ptu)] which contain besides the phosphine unit, a substituted thiourea bonded to the metal via the thione-S atom. The stereochemistry of the series of copper(I) halide complexes (CuX, X = Cl, Br, I) has been established by IR spectral and ¹H, ¹³C NMR spectral data. All crystal structures of all complexes have been confirmed by X-ray diffraction study.

[CuCl(PPh₃)₂(ptu)] and [CuBr(PPh₃)₂(ptu)] complexes are monomeric distorted tetrahedral. Copper atom is coordinated by two phosphorus atoms of two triphenylphosphine molecules, one sulfur atom of phenylthiourea molecule, and either one chloride or bromide atom. Both complexes, which are isomorphous and isostructural, crystallize in the triclinic space group $P\bar{1}$ with $Z = 2$.

[CuI(PPh₃)₂(ptu)] complex is monomeric distorted tetrahedral. The asymmetric unit contains two independent molecules. The copper(I) ion in the complex is coordinated by two phosphorus atoms of two triphenylphosphine molecules, one sulfur atom of phenylthiourea molecule and one iodide atom.

[CuI(PPh₃)₂(ptu)] complex crystallines in the triclinic space group $P\bar{1}$ and $Z = 4$.

Furthermore, as results from X-ray Fluorescence spectrometry, elemental analysis, Infrared spectroscopy and ¹H, ¹³C NMR spectroscopy support the structures which give rise from the single-crystal X-ray diffraction technique.

The substituted thiourea and triphenylphosphine complexes have attracted considerable attention because of their various application properties. An increasing

investigation of the complexes of these groups has focused on acquiring well-defined solid-state structures in order to understand about the nature versatile coordination chemistry. In the future it is, however, hoped that the studies of the mixed ligand Cu(I) complexes and the related complexes of Ag(I) and Au(I) with substituted thiourea and triphenylphosphine also will increase our understanding about the relationship between copper(I) salts with triphenylphosphine and substituted thiourea as well as relationship with their silver(I) and gold(I) counterparts.

Bibliography

- Akrivos, P.D. 2001. Recent studies in the coordination chemistry of heterocyclic thiones and thionates. *Coordination Chemistry Reviews*. 213, 181–210.
- Albano, V.G., Bellon, P.L., Ciani, G. and Manasser, M. 1972. Crystal and molecular structure of monoclinic di- μ -chloro-tris(tri-phenylphosphine)dicopper(I), $\text{Cu}_2\text{Cl}_2(\text{PPh}_3)_3$. *J.C.S. Dalton*. 171-175.
- Alexander, Y.V., Felix, D. S., Nail, G. Z., Maria, G. B., Dmitry, B. K., Vasiliy, V.B., Igor, A.L. 2006. Copper(I) complexes of N-thioacylamido(thio) phosphates and Triphenylphosphine. *Inorganica Chimica Acta*. 359, 475-483.
- Aslanidis, P., Hadjikakou, S. K., Karagiannidis, P., Gdaniec, M. and Kosturkiewicz, Z. 1993. Four-Coordinate Copper(I) iodide Complexes with Triphenylphosphine Heterocyclic Thiones Ligands. The Crystal Structure of $[\text{Cu}(\text{PPh}_3)_2(\text{pymtH})\text{I}]$. *Polyhedron*. 12, 2221-2226.
- Aslanidis, P., Hadjikakou, S.K., Karagiannidis, P. Kojic-Prodic, B. and Luic, M. 1994. Preparation and spectral studies of dinuclear mixed-ligand copper(I) complexes. The crystal structure of bis[μ -s(pyridine-2-thione)(tntp) copper(I) bromide]. *Polyhedron*. 13, 3119-3125.
- Aslanidis, P., Hadjikakou, S.K., Karagiannidis, P. and Cox, P.J. 1998. Synthesis and characterization of copper(I) complexes with triphenylphosphine and heterocyclic thiones ligands the Structure of (thiazolidine-2-thione) (bis(triphenylphosphine)copper(I) chloride. *Inorganica Chimica Acta*. 271, 243-247.

- Aslanidis, P., Cox, P.J., Divanidis, S. and Tsipis, A. 2002. Copper(I) halide complexes with 1, 3-propanebis(diphenylphosphine) and heterocyclic thione ligands: Crystal and electronic structure (DFT) of [CuCl(pymtH)(dppp)], [CuBr(pymtH)(dppp)] and [Cu(μ -I)(dppp)]₂. *Inorganic Chemistry*. 41, 6875-6886.
- Barron, P.F., Dyason, J.C., Healy, P.C., Engelhardt, L.M., Pakawatchai, C., Patrick, V.A. and White, A.H. 1987. Lewis-base Adducts of Group 11 Metal(I) Compounds. Part 28. Solid-state Phosphorus-31 Cross-polarization Magic-angle Spinning Nuclear Magnetic Resonance and Structural Studies on the Mononuclear 3:1 Adducts of Triphenylphosphine with Copper(I) Halides. *J. Chem. Soc., Dalton Trans.* 1099-1106.
- Bowmaker, G.A., Dyason, J.C., Healy, P.C., Engelhardt, L.M., Pakawatchai, C. and White, A.H. 1987. Lewis-Base Adducts of Group 11 Metal(I) Compounds. Part 27. Solid-state Phosphorus-31 Cross-polarization Magic-angle Spinning Nuclear Magnetic Resonance, Far-infrared, and Structural Studies on the Mononuclear 2:1 Adducts of Triphenylphosphine with Copper(I) and Gold(I) Halides. *J. Chem. Soc., Dalton Trans.* 1089-1097.
- Bowmaker, G.A. 1994. Vibrational Spectra and Crystal Structures of Tris- and Tetrakis-(ethylenethiourea)copper(I) Systems. *Aust. J. Chem.* 47, 15-24.
- Cotton, F. A and Wilkinson, G. 1988. *Advanced Inorganic Chemistry*. 5th ed., New York: John Wiley & Sons.
- Cox, P.J., Aslanidis, P., Karagiannidis, P., Hadjidakou, S.K. 1999. Synthesis, spectroscopic and computational studies plus crystal structure of [(bis-benzo-1,3-thiazolidine-2-thione)(bis-triphenylphosphine)copper(I)] [Chloro(benzothiazolidine-2-thione)(bis-triphenylphosphine)copper(I)]. *Polyhedron*. 18, 1501-1506.

- Dyason, J.C., Engelhardt, L.M., Pakawatchai, P., Healy, P.C. and White, A.H. 1985. Lewis-Base Adducts of Group 1B Metal(I) Compounds. XXI+ The Crystal and Molecular Structures of the Unsolvated Forms of Dibromotris(triphenylphosphine)dicopper(I) and 'step' Tetrabromotetrakis(triphenylphosphine)tetracopper(I). *Aust. J. Chem.* 38, 1243-1250.
- Hadjikakou, S.K., Aslanidis, P., Karagiannidis, P., Mentzafos, D. and Terzis, A. 1991. Synthesis and photolysis of mixed copper(I) complexes with thiones and tri-*p*-tolylphosphine or triphenylphosphine; X-ray crystal structure of bis[copper(I)(1,3-thiazolidine-2-thione)(tri-*p*-tolylphosphine)chloride]. *Polyhedron*.10, 935-940.
- Hadjikakou, S.K., Aslanidis, P., Karagiannidis, P., Mentzafos, D. and Terzis, A. 1991. Synthesis and photolysis of a new series of Cu(I) complexes with tri-*o*-tolylphosphine and heterocyclic thiones as ligands. The crystal structure of (thiazolidine-2-thione)(tri-*o*-tolylphosphine) copper(I) bromide. *Inorganica Chimica Acta*. 186, 199-204.
- Hadjikakou, S.K., Aslanidis, P., Akriivos, P.D., Karagiannidis, P., Kojic-Prodic, B. and Luic, M. 1992. Study of mixed ligand copper(I) complexes with tri-*m*-tolylphosphine (tntp) and heterocyclic thiones. Crystal structures of bis[μ -S(benzimidazoline-2-thione)(tntp) copper(I) chloride] and bis[μ -Br(thiazolidine-2-thione)(tntp) copper(I)]. *Inorganica Chimica Acta*. 197, 31-38.
- Hall, S.R., du Boulay, D.J. and Olthof-Hazekamp, R. 1997 Eds. *Xtal 3.6 System*. University of wastem Astrarea.
- Jianping, L. and Kazuyuki, T. 1996. Synthesis and Crystal Structure of A Binuclear Copper (I) Bromide Complex of Benz-1,3-thiazolidine-2-thione and Triphenylphosphine, [Cu(btzdtH)(PPh₃)Br]₂. *Polyhedron*. 15, 2127-2130.

- Karagiannidis, P., Aslanidis, P., Papastefanou, S., Mentzafos, D., Hountas, A. and Terzis, A. 1989. Cu(I) Complexes with Heterocyclic Thiones and Triphenylphosphine as Ligands. The Crystal Structure of $[\text{Cu}(\text{tzdtH})_2(\text{PPh}_3)_2]\text{NO}_3$. *Inorganica Chimica Acta*. 156, 265-270.
- Karagiannidis, P., Aslanidis, P., Papastefanou, S., Mentzafos, D., Hountas, A. and Terzis, A. 1990. Synthesis and Characterization of Copper(I) halide Complexes with Heterocyclic Thiones and Triphenylphosphine as Ligands. The X-ray Crystal Structure of Copper(I)1-methyl-1,3-imidazoline-2-thione bis(triphenylphosphine)bromide, $[\text{Cu}(\text{PPh}_3)_2\text{meimtH}]\text{Br}$. *Polyhedron*. 9, 981-986.
- Karagiannidis, P., Hadjikakou, S.K., Aslanidis, P. and Hountas, A. 1990. Synthesis and photochemical study of Cu(I) complexes with tri-*p*-tolylphosphine and heterocyclic thiones. The crystal structure of $[\text{CuCl}(\text{pymtH})(\text{p-CH}_3\text{C}_6\text{H}_4)_3\text{P}]_2$. *Inorganica Chimica Acta*. 178, 27-34.
- Lecomte, C., Skoulika, St., Aslanidis, P., Karagiannidis, P. and Papastefanou, St. 1989. Copper(I) Bromide Complexes with Heterocyclic Thiones and Triphenylphosphine as Ligands. The X-ray Crystal Structure of Copper(I) Pyrimidine-2-thione Bis(triphenylphosphine) Bromide $[\text{Cu}(\text{PPh}_3)_2(\text{PymtH})\text{Br}]$. *Polyhedron*. 8, 1103-1109.
- Lobana, T. S., Paul, S. and Castineiras, A. 1997. The chemistry of pyridinethiols and related ligands-VII. Preparation and spectroscopy of mixed-ligand copper(I) complexes: the crystal structure of first mixed-ligand dinuclear [iodo(pyridine-2-thione)(tri-*p*- tolylphosphine)copper(I)]₂ complex. *Polyhedron*. 16, 4023-4031.

- Marcello, G., Maurizio, L., Luciano, M., Maria, A.P., Matteo, T. and Roberto, C.
2006. Cu(I) Dinuclear Complexes with Tripodal Ligands vs Monodentate Donors: Triphenylphosphine, Thiourea, and Pyridine. A ^1H NMR Titration Study. *Inorganic Chemistry*. 45, 3456 -3466.
- Negita, H., Hiura, M., Kushi, Y., Kuramoto, M. and Okuda, T. 1981. The Crystal Structure of Di- μ -Bromo-tris(triphenylphosphine)dicopper(II). *Bull. Chem. Soc. Jpn.* 54, 1247-1248.
- Sheldrick, G.M. 2000. SHELXL NT Version 6.12, Bruker Analytical X-ray System, Inc: Madison, WI, USA.
- Singh, R. and Dikshit, S.K. 1995. Synthesis and characterization of mixed ligand copper(I) complexes containing halides, triphenylarsine and *N,N*-dimethyl-*N'*-phenylthiourea (dmptH), *N,N*-dibutyl-*N'*-phenylthiourea (dbptH) or 1,3-thiazolidine-2-thione (tzdtH). The X-ray crystal structure of $[\text{Cu}(\text{PPh}_3)_2(\text{dmptH})\text{Cl}]$. *Polyhedron*. 14, 1799-1807.
- Skoulika, S., Aubry, A., Karagianidis, P., Aslanidis, P. and Papastefanou, S. 1991. New Copper(I) Chloride Complexes with Heterocyclic Thiones and Triphenylphosphine as Ligands. Crystal Structure of $[\text{Cu}(\text{PPh}_3)_2(\text{bzimtH}_2)\text{Cl}]$ CH_3COCH_3 and $[\text{Cu}(\text{PPh}_3)_2(\text{nbzimtH}_2)\text{Cl}]$. *Inorganica Chimica Acta*. 183, 207-211.
- Spofford, W.A. and Amma, E.L. 1970. The Crystal Structure of Bis(thiourea) Copper(I) chloride. *Acta. Cryst.* 26, 1474-1483.
- Tanchatchawal, S. 2004. Crystal Structures of Some Copper (I) Complexes Containing Sulfer Donor-Atom Ligands. Master of Science Thesis, Prince of Songkla University, Songkha, Thailand.

Yamaguchi, A., Penland, R.B., Mizushima, S., Lane, T.J., Curran, C. and Quagliano, J.V. 1958. Infrared Absorption Spectra of Inorganic Coordination Complexes. XIV. Infrared Studies of Some Metal Thiourea Complexes. *J. Amer. Chem. Soc.* 80, 527-529.

Appendix A

Calculation of unit cell volume

Table 18 The equation of calculation of unit cell volume depend on crystal system :

Crystal system	Equation
Cubic	$V = a^3$
Tetragonal	$V = a^2 c$
Orthorhombic	$V = abc$
Hexagonal	$V = (3a^2 c) / 2 = 0.886 a^2 c$
Monoclinic	$V = abc \sin \beta$
Triclinic	$V = abc(1 - \cos^2 \alpha - \cos^2 \beta - \cos^2 \gamma + 2 \cos \alpha \cdot \cos \beta \cdot \cos \gamma)^{1/2}$

Calculation of number of molecules per unit cell (Z)

$$Z = \frac{D \times V \times N}{F_w}$$

D = Density of crystal (g/ cm^3)

V = Volume of unit cell (cm^3)

N = Avogadro number ($6.02 \times 10^{23} \text{ mol}^{-1}$)

F_w = Formula weight

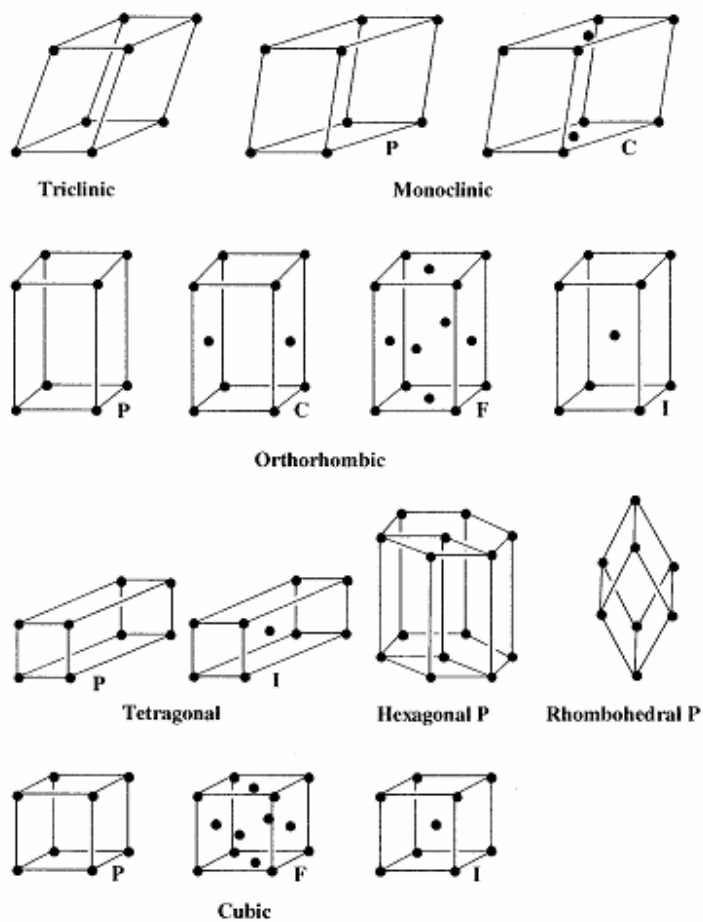

Figure 62 The Bravais lattices.

Appendix B

The crystallographic data

Table 19 Non – hydrogen atom coordinates and isotropic thermal parameters of
[CuCl(PPh₃)₂(ptu)].

Atom	x/a	y/b	z/c	U(eq) A**2
Cu(1)	0.25478(3)	0.47399(2)	0.24039(1)	*0.0344(2)
Cl(1)	0.47479(6)	0.46105(6)	0.24127(3)	*0.0463(4)
S(1)	0.17698(6)	0.53409(5)	0.10795(3)	*0.0371(4)
P(1)	0.24736(6)	0.64815(5)	0.32255(3)	*0.0333(4)
P(2)	0.12525(6)	0.27878(5)	0.24380(3)	*0.0325(4)
C(1)	0.2087(2)	0.4346(2)	0.0351(1)	*0.033(2)
N(1)	0.3115(2)	0.3852(2)	0.0545(1)	*0.044(1)
N(2)	0.1327(2)	0.4072(2)	-0.0413(1)	*0.054(2)
C(2)	0.3435(2)	0.2940(2)	0.0011(1)	*0.037(2)
C(3)	0.4270(3)	0.3304(2)	-0.0476(1)	*0.055(2)
C(4)	0.4655(3)	0.2409(3)	-0.0935(2)	*0.064(2)
C(5)	0.4191(3)	0.1185(3)	-0.0913(2)	*0.062(2)
C(6)	0.3362(3)	0.0833(3)	-0.0438(2)	*0.064(2)
C(7)	0.2978(3)	0.1706(2)	0.0026(1)	*0.048(2)
C(11)	0.3741(2)	0.7953(2)	0.3320(1)	*0.040(2)
C(12)	0.4833(3)	0.7938(2)	0.2994(2)	*0.049(2)
C(13)	0.5895(4)	0.8996(3)	0.3144(2)	*0.068(3)
C(14)	0.5894(4)	1.0077(3)	0.3611(2)	*0.073(3)
C(15)	0.4832(4)	1.0109(3)	0.3938(2)	*0.080(3)
C(16)	0.3745(4)	0.9053(2)	0.3799(2)	*0.060(2)
C(21)	0.2695(2)	0.6478(2)	0.4319(1)	*0.039(2)

Table 19 Non – hydrogen atom coordinates and isotropic thermal parameters of
 [CuCl(PPh₃)₂(ptu)] (cont.).

Atom	x/a	y/b	z/c	U(eq) A**2
C(22)	0.3922(3)	0.6339(2)	0.4751(1)	*0.052(2)
C(23)	0.4162(4)	0.6281(3)	0.5579(2)	*0.067(2)
C(24)	0.3180(4)	0.6356(3)	0.5967(2)	*0.075(3)
C(25)	0.1975(4)	0.6500(3)	0.5551(2)	*0.078(3)
C(26)	0.1723(3)	0.6576(3)	0.4727(1)	*0.058(2)
C(31)	0.0794(2)	0.6735(2)	0.2887(1)	*0.035(2)
C(32)	-0.0316(3)	0.5755(2)	0.2858(2)	*0.052(2)
C(33)	-0.1628(3)	0.5849(3)	0.2623(2)	*0.059(3)
C(34)	-0.1870(3)	0.6905(3)	0.2392(2)	*0.060(2)
C(35)	-0.0804(3)	0.7855(3)	0.2372(2)	*0.066(3)
C(36)	0.0534(3)	0.7784(2)	0.2626(2)	*0.052(2)
C(41)	0.1584(2)	0.1426(2)	0.1892(1)	*0.032(2)
C(42)	0.2894(3)	0.1296(2)	0.2127(2)	*0.047(2)
C(43)	0.3185(3)	0.0235(3)	0.1792(2)	*0.055(2)
C(44)	0.2198(3)	-0.0673(2)	0.1212(2)	*0.053(2)
C(45)	0.0917(4)	-0.0541(2)	0.0960(2)	*0.052(2)
C(46)	0.0598(3)	0.0506(2)	0.1303(2)	*0.042(2)
C(51)	-0.0564(2)	0.2564(2)	0.2006(1)	*0.036(2)
C(52)	-0.0996(3)	0.2860(2)	0.1239(2)	*0.053(2)
C(53)	-0.2343(3)	0.2803(3)	0.0900(2)	*0.067(3)
C(54)	-0.3283(4)	0.2449(3)	0.1325(2)	*0.072(3)
C(55)	-0.2893(3)	0.2135(3)	0.2065(2)	*0.073(3)
C(56)	-0.1552(3)	0.2172(3)	0.2407(2)	*0.056(2)
C(61)	0.1366(2)	0.2365(2)	0.3445(1)	*0.039(2)
C(62)	0.1011(5)	0.1152(3)	0.3540(2)	*0.105(4)
C(63)	0.1104(6)	0.0866(4)	0.4307(3)	*0.133(5)

Table 19 Non – hydrogen atom coordinates and isotropic thermal parameters of
[CuCl(PPh₃)₂(ptu)] (cont.).

Atom	x/a	y/b	z/c	U(eq) Å ²
C(64)	0.1550(4)	0.1791(4)	0.4983(2)	*0.095(3)
C(65)	0.1865(5)	0.2972(4)	0.4896(2)	*0.104(4)
C(66)	0.1778(4)	0.3255(3)	0.4128(2)	*0.076(3)

Table 20 Hydrogen atom coordinates and Isotropic thermal parameters of
 $[\text{CuCl}(\text{PPh}_3)_2(\text{ptu})]$.

Atom	x/a	y/b	z/c	U(eq) Å ²
H(1)	0.363(2)	0.406(2)	0.105(1)	0.044(6)
H(2a)	0.153(3)	0.367(2)	-0.077(1)	0.055(7)
H(2b)	0.063(3)	0.431(2)	-0.055(1)	0.051(7)
H(3)	0.453(2)	0.413(2)	-0.050(1)	0.050(7)
H(4)	0.521(3)	0.272(2)	-0.125(2)	0.071(8)
H(5)	0.443(3)	0.060(2)	-0.124(2)	0.078(8)
H(6)	0.304(3)	0.002(3)	-0.042(2)	0.079(9)
H(7)	0.245(2)	0.146(2)	0.036(1)	0.053(7)
H(12)	0.479(3)	0.714(2)	0.266(2)	0.079(9)
H(13)	0.672(3)	0.898(3)	0.296(2)	0.09(1)
H(14)	0.669(3)	1.083(3)	0.373(2)	0.073(9)
H(15)	0.470(3)	1.078(3)	0.422(2)	0.071(8)
H(16)	0.300(3)	0.904(2)	0.400(1)	0.061(8)
H(22)	0.461(2)	0.625(2)	0.449(1)	0.056(7)
H(23)	0.508(3)	0.618(3)	0.587(2)	0.088(9)
H(24)	0.335(3)	0.629(2)	0.653(2)	0.084(9)
H(25)	0.122(3)	0.659(3)	0.576(2)	0.09(1)
H(26)	0.095(2)	0.669(2)	0.450(1)	0.040(7)
H(32)	-0.014(3)	0.501(3)	0.301(2)	0.082(9)
H(33)	-0.238(3)	0.521(2)	0.256(2)	0.067(9)
H(34)	-0.278(3)	0.700(2)	0.220(2)	0.071(8)
H(35)	-0.097(3)	0.861(3)	0.221(2)	0.092(9)
H(36)	0.133(3)	0.846(2)	0.264(1)	0.051(7)
H(42)	0.363(3)	0.192(2)	0.252(1)	0.048(7)
H(43)	0.410(3)	0.020(2)	0.200(1)	0.053(7)
H(44)	0.240(3)	-0.139(2)	0.097(1)	0.069(7)

Table 20 Hydrogen atom coordinates and isotropic thermal parameters of
[CuCl(PPh₃)₂(ptu)] (cont.).

Atom	x/a	y/b	z/c	U(eq) A**2
H(45)	0.020(3)	-0.113(2)	0.060(1)	0.051(8)
H(46)	-0.033(3)	0.053(2)	0.112(1)	0.049(7)
H(52)	-0.029(3)	0.322(2)	0.103(2)	0.075(9)
H(53)	-0.259(3)	0.299(2)	0.036(2)	0.075(9)
H(54)	-0.420(3)	0.239(3)	0.110(2)	0.074(9)
H(55)	-0.352(3)	0.184(2)	0.237(2)	0.080(9)
H(56)	-0.126(3)	0.196(2)	0.292(2)	0.062(8)
H(62)	0.059(3)	0.050(3)	0.306(2)	0.10(1)
H(63)	0.067(4)	0.007(4)	0.429(2)	0.13(1)
H(64)	0.158(3)	0.161(3)	0.549(2)	0.11(1)
H(65)	0.223(4)	0.356(3)	0.535(2)	0.12(1)
H(66)	0.212(3)	0.400(3)	0.408(2)	0.10(1)

Table 21 Non – hydrogen thermal parameters of [CuCl(PPh₃)₂(ptu)].

Atom	U11	U22	U33	U12	U13	U23
Cu(1)	0.0340(2)	0.0354(2)	0.0339(1)	0.0098(2)	0.0114(1)	0.0031(1)
Cl(1)	0.0285(4)	0.0641(4)	0.0445(3)	0.0150(4)	0.0062(3)	0.0070(3)
S(1)	0.0467(4)	0.0394(3)	0.0297(2)	0.0205(3)	0.0105(3)	0.0061(2)
P(1)	0.0383(5)	0.0324(3)	0.0283(2)	0.0089(3)	0.0100(3)	0.0030(2)
P(2)	0.0322(4)	0.0318(3)	0.0352(3)	0.0100(3)	0.0110(3)	0.0067(2)
C(1)	0.038(2)	0.034(1)	0.029(1)	0.011(1)	0.011(1)	0.0071(9)
N(1)	0.050(2)	0.056(1)	0.0273(9)	0.027(1)	0.004(1)	-0.0023(9)
N(2)	0.061(2)	0.074(1)	0.032(1)	0.041(1)	0.004(1)	-0.002(1)
C(2)	0.036(2)	0.045(1)	0.030(1)	0.017(1)	0.007(1)	0.0008(9)
C(3)	0.064(2)	0.047(1)	0.049(1)	0.003(2)	0.024(2)	-0.001(1)
C(4)	0.052(2)	0.084(2)	0.053(2)	0.007(2)	0.028(2)	-0.006(2)
C(5)	0.054(2)	0.066(2)	0.064(2)	0.025(2)	0.018(2)	-0.012(1)
C(6)	0.070(2)	0.045(2)	0.078(2)	0.020(2)	0.024(2)	0.002(1)
C(7)	0.046(2)	0.049(1)	0.051(1)	0.011(1)	0.020(1)	0.008(1)
C(11)	0.044(2)	0.038(1)	0.030(1)	0.004(1)	0.004(1)	0.0037(9)
C(12)	0.041(2)	0.044(1)	0.053(1)	-0.001(2)	0.009(2)	0.011(1)
C(13)	0.049(3)	0.065(2)	0.080(2)	-0.002(2)	0.013(2)	0.022(2)
C(14)	0.064(3)	0.059(2)	0.068(2)	-0.019(2)	-0.000(2)	0.016(2)
C(15)	0.122(4)	0.040(2)	0.055(2)	-0.004(2)	0.014(2)	-0.006(1)
C(16)	0.077(3)	0.042(2)	0.052(2)	0.001(2)	0.022(2)	-0.002(1)
C(21)	0.050(2)	0.032(1)	0.030(1)	0.010(1)	0.010(1)	0.0021(9)
C(22)	0.058(2)	0.049(1)	0.043(1)	0.014(2)	0.006(1)	0.007(1)
C(23)	0.088(3)	0.059(2)	0.042(1)	0.021(2)	-0.007(2)	0.009(1)
C(24)	0.120(3)	0.073(2)	0.033(1)	0.034(2)	0.015(2)	0.013(1)
C(25)	0.112(3)	0.094(2)	0.046(1)	0.044(2)	0.040(2)	0.017(2)
C(26)	0.073(2)	0.073(2)	0.041(1)	0.034(2)	0.024(2)	0.013(1)
C(31)	0.036(2)	0.033(1)	0.031(1)	0.007(1)	0.009(1)	-0.0002(9)

Table 21 Non – hydrogen thermal parameters of [CuCl(PPh₃)₂(ptu)] (cont.).

Atom	U11	U22	U33	U12	U13	U23
C(32)	0.042(2)	0.040(1)	0.071(2)	0.010(2)	0.011(2)	0.009(1)
C(33)	0.036(2)	0.055(2)	0.077(2)	0.004(2)	0.012(2)	0.004(2)
C(34)	0.046(2)	0.077(2)	0.057(2)	0.029(2)	0.009(2)	0.006(2)
C(35)	0.066(3)	0.065(2)	0.078(2)	0.035(2)	0.016(2)	0.026(2)
C(36)	0.052(2)	0.047(1)	0.060(2)	0.016(2)	0.016(2)	0.018(1)
C(41)	0.028(2)	0.031(1)	0.036(1)	0.006(1)	0.008(1)	0.005(1)
C(42)	0.040(2)	0.050(2)	0.047(1)	0.016(2)	0.006(1)	0.000(1)
C(43)	0.049(2)	0.064(2)	0.060(2)	0.032(2)	0.015(2)	0.012(1)
C(44)	0.065(2)	0.043(1)	0.058(2)	0.024(2)	0.022(2)	0.007(1)
C(45)	0.055(3)	0.037(1)	0.055(2)	0.004(2)	0.012(2)	-0.004(1)
C(46)	0.032(2)	0.039(1)	0.050(1)	0.006(2)	0.009(2)	0.004(1)
C(51)	0.027(2)	0.025(1)	0.048(1)	0.002(1)	0.008(1)	-0.002(1)
C(52)	0.035(2)	0.046(1)	0.070(2)	0.003(2)	0.005(2)	0.020(1)
C(53)	0.048(3)	0.053(2)	0.085(2)	0.013(2)	-0.010(2)	0.014(2)
C(54)	0.032(3)	0.062(2)	0.104(3)	0.015(2)	-0.003(2)	-0.016(2)
C(55)	0.033(2)	0.084(2)	0.084(2)	-0.000(2)	0.021(2)	-0.024(2)
C(56)	0.040(2)	0.067(2)	0.051(2)	0.005(2)	0.016(2)	-0.006(1)
C(61)	0.040(2)	0.041(1)	0.041(1)	0.014(1)	0.014(1)	0.012(1)
C(62)	0.220(5)	0.054(2)	0.069(2)	0.050(2)	0.076(3)	0.025(2)
C(63)	0.273(6)	0.081(2)	0.107(3)	0.083(3)	0.114(4)	0.062(2)
C(64)	0.129(3)	0.123(3)	0.061(2)	0.055(3)	0.043(2)	0.052(2)
C(65)	0.151(4)	0.088(2)	0.042(2)	-0.016(3)	0.014(2)	0.009(2)
C(66)	0.114(3)	0.050(2)	0.043(1)	-0.009(2)	0.011(2)	0.008(1)

Table 22 Non – hydrogen atom coordinates and isotropic thermal parameters of
[CuBr(PPh₃)₂(ptu)].

Atom	x/a	y/b	z/c	U(eq) A**2
Cu(1)	0.24122(3)	0.47691(3)	0.23712(2)	*0.0337(2)
Br(1)	0.47277(3)	0.46158(3)	0.24772(2)	*0.0485(2)
S(1)	0.17258(8)	0.53493(7)	0.10567(4)	*0.0375(5)
P(1)	0.23191(7)	0.65252(7)	0.31949(4)	*0.0327(5)
P(2)	0.11496(7)	0.28136(7)	0.24087(4)	*0.0329(5)
C(1)	0.2068(3)	0.4343(2)	0.0338(2)	*0.034(2)
N(1)	0.3086(3)	0.3846(3)	0.0524(2)	*0.046(2)
N(2)	0.1323(3)	0.4056(3)	-0.0421(2)	*0.055(2)
C(2)	0.3433(3)	0.2935(3)	0.0000(2)	*0.037(2)
C(3)	0.4278(4)	0.3292(4)	-0.0476(2)	*0.055(3)
C(4)	0.4683(4)	0.2394(4)	-0.0926(2)	*0.066(3)
C(5)	0.4234(4)	0.1172(4)	-0.0911(2)	*0.065(3)
C(6)	0.3389(4)	0.0816(4)	-0.0444(3)	*0.065(3)
C(7)	0.2988(4)	0.1689(3)	0.0012(2)	*0.052(3)
C(11)	0.3556(3)	0.8002(3)	0.3304(2)	*0.039(2)
C(12)	0.4649(3)	0.8010(3)	0.2993(2)	*0.050(2)
C(13)	0.5693(4)	0.9080(4)	0.3157(3)	*0.068(3)
C(14)	0.5654(5)	1.0147(4)	0.3641(3)	*0.076(3)
C(15)	0.4561(5)	1.0157(4)	0.3945(3)	*0.075(3)
C(16)	0.3521(4)	0.9090(3)	0.3788(2)	*0.058(3)
C(21)	0.2505(3)	0.6489(3)	0.4277(2)	*0.040(2)
C(22)	0.3726(4)	0.6377(3)	0.4709(2)	*0.052(3)
C(23)	0.3936(5)	0.6295(3)	0.5525(2)	*0.066(3)
C(24)	0.2930(5)	0.6311(4)	0.5908(3)	*0.074(4)
C(25)	0.1735(5)	0.6431(4)	0.5496(2)	*0.078(4)
C(26)	0.1509(4)	0.6530(4)	0.4682(2)	*0.059(3)

Table 22 Non – hydrogen atom coordinates and isotropic thermal parameters of
 [CuBr(PPh₃)₂(ptu)] (cont.).

Atom	x/a	y/b	z/c	U(eq) A**2
C(31)	0.0675(3)	0.6793(3)	0.2867(2)	*0.034(2)
C(32)	-0.0417(3)	0.5809(3)	0.2829(2)	*0.050(2)
C(33)	-0.1707(4)	0.5892(4)	0.2598(2)	*0.061(3)
C(34)	-0.1942(4)	0.6970(4)	0.2377(2)	*0.058(3)
C(35)	-0.0907(4)	0.7924(4)	0.2367(2)	*0.064(3)
C(36)	0.0412(4)	0.7852(3)	0.2608(2)	*0.049(2)
C(41)	0.1488(3)	0.1434(3)	0.1866(2)	*0.035(2)
C(42)	0.2758(3)	0.1269(3)	0.2106(2)	*0.047(2)
C(43)	0.3063(4)	0.0213(3)	0.1772(2)	*0.056(3)
C(44)	0.2109(4)	-0.0695(3)	0.1184(2)	*0.057(3)
C(45)	0.0859(4)	-0.0538(3)	0.0927(2)	*0.054(3)
C(46)	0.0541(3)	0.0512(3)	0.1269(2)	*0.044(2)
C(51)	-0.0640(3)	0.2592(2)	0.1986(2)	*0.037(2)
C(52)	-0.1039(3)	0.2884(3)	0.1222(2)	*0.051(3)
C(53)	-0.2359(4)	0.2821(3)	0.0879(3)	*0.062(3)
C(54)	-0.3304(4)	0.2484(4)	0.1294(3)	*0.070(3)
C(55)	-0.2947(4)	0.2180(4)	0.2045(3)	*0.069(3)
C(56)	-0.1620(4)	0.2226(3)	0.2393(2)	*0.055(3)
C(61)	0.1286(3)	0.2391(3)	0.3414(2)	*0.039(2)
C(62)	0.0752(5)	0.1182(4)	0.3506(3)	*0.074(3)
C(63)	0.0904(6)	0.0888(5)	0.4275(3)	*0.091(4)
C(64)	0.1592(5)	0.1787(5)	0.4946(3)	*0.087(4)
C(65)	0.2089(6)	0.2955(5)	0.4864(3)	*0.103(4)
C(66)	0.1958(4)	0.3255(4)	0.4095(2)	*0.071(3)

Table 23 Hydrogen atom coordinates and isotropic thermal parameters of
[CuBr(PPh₃)₂(ptu)].

Atom	x/a	y/b	z/c	U(eq) Å ²
H(1)	0.349(3)	0.404(3)	0.098(2)	0.044(9)
H(2a)	0.060(4)	0.440(4)	-0.055(2)	0.10(1)
H(2b)	0.153(3)	0.366(3)	-0.077(2)	0.039(9)
H(3)	0.450(3)	0.412(3)	-0.052(2)	0.07(1)
H(4)	0.520(3)	0.272(3)	-0.123(2)	0.06(1)
H(5)	0.457(3)	0.056(3)	-0.122(2)	0.07(1)
H(6)	0.315(4)	-0.003(4)	-0.037(2)	0.09(1)
H(7)	0.248(3)	0.147(3)	0.033(2)	0.07(1)
H(12)	0.466(3)	0.724(3)	0.263(2)	0.042(8)
H(13)	0.652(4)	0.905(3)	0.296(2)	0.09(1)
H(14)	0.644(4)	1.087(3)	0.375(2)	0.09(1)
H(15)	0.446(3)	1.087(3)	0.425(2)	0.07(1)
H(16)	0.283(3)	0.911(3)	0.398(2)	0.05(1)
H(22)	0.438(3)	0.636(3)	0.444(2)	0.039(9)
H(23)	0.478(4)	0.623(3)	0.575(2)	0.08(1)
H(24)	0.316(4)	0.632(3)	0.645(2)	0.09(1)
H(25)	0.097(4)	0.646(4)	0.573(3)	0.10(2)
H(26)	0.066(3)	0.663(3)	0.440(2)	0.08(1)
H(32)	-0.024(3)	0.509(3)	0.297(2)	0.049(9)
H(33)	-0.246(3)	0.521(3)	0.259(2)	0.07(1)
H(34)	-0.290(3)	0.701(3)	0.221(2)	0.07(1)
H(35)	-0.106(3)	0.858(3)	0.217(2)	0.06(1)
H(36)	0.113(3)	0.854(3)	0.265(2)	0.048(9)
H(42)	0.335(3)	0.185(3)	0.252(2)	0.06(1)
H(43)	0.401(3)	0.009(3)	0.199(2)	0.08(1)
H(44)	0.228(3)	-0.144(3)	0.095(2)	0.07(1)

Table 23 Hydrogen atom coordinates and isotropic thermal parameters of
[CuBr(PPh₃)₂(ptu)] (cont.).

Atom	x/a	y/b	z/c	U(eq) A**2
H(45)	0.017(3)	-0.114(3)	0.054(2)	0.06(1)
H(46)	-0.031(2)	0.058(2)	0.114(1)	0.028(7)
H(52)	-0.040(3)	0.316(3)	0.097(2)	0.06(1)
H(53)	-0.260(3)	0.303(3)	0.039(2)	0.07(1)
H(54)	-0.421(4)	0.248(3)	0.108(2)	0.07(1)
H(55)	-0.350(4)	0.194(4)	0.236(2)	0.09(1)
H(56)	-0.142(3)	0.201(3)	0.288(2)	0.06(1)
H(62)	0.033(4)	0.052(4)	0.303(3)	0.13(2)
H(63)	0.048(5)	0.007(5)	0.430(3)	0.15(2)
H(64)	0.181(3)	0.164(3)	0.545(2)	0.07(1)
H(65)	0.263(4)	0.356(4)	0.531(3)	0.12(2)
H(66)	0.241(3)	0.406(3)	0.404(2)	0.06(1)

Table 24 Non – hydrogen thermal parameters of [CuBr(PPh₃)₂(ptu)].

Atom	U11	U22	U33	U12	U13	U23
Cu(1)	0.0308(2)	0.0368(2)	0.0344(2)	0.0089(2)	0.0113(1)	0.0051(2)
Br(1)	0.0277(2)	0.0673(2)	0.0502(2)	0.0155(2)	0.0068(1)	0.0105(2)
S(1)	0.0462(4)	0.0404(4)	0.0307(4)	0.0201(4)	0.0107(3)	0.0071(3)
P(1)	0.0330(4)	0.0342(4)	0.0298(4)	0.0059(3)	0.0099(3)	0.0043(3)
P(2)	0.0306(4)	0.0330(4)	0.0370(4)	0.0091(3)	0.0114(3)	0.0074(3)
C(1)	0.040(2)	0.033(2)	0.031(2)	0.009(1)	0.013(1)	0.009(1)
N(1)	0.054(2)	0.060(2)	0.027(1)	0.031(1)	0.006(1)	0.000(1)
N(2)	0.066(2)	0.073(2)	0.031(2)	0.042(2)	0.007(1)	-0.003(1)
C(2)	0.035(2)	0.045(2)	0.030(2)	0.016(1)	0.005(1)	0.003(1)
C(3)	0.064(2)	0.048(2)	0.052(2)	0.005(2)	0.028(2)	0.004(2)
C(4)	0.058(2)	0.087(3)	0.054(2)	0.009(2)	0.033(2)	0.004(2)
C(5)	0.059(3)	0.068(3)	0.067(3)	0.028(2)	0.018(2)	-0.009(2)
C(6)	0.074(3)	0.044(2)	0.080(3)	0.019(2)	0.026(2)	0.005(2)
C(7)	0.052(2)	0.052(2)	0.056(2)	0.013(2)	0.026(2)	0.009(2)
C(11)	0.040(2)	0.040(2)	0.032(2)	0.003(1)	0.006(1)	0.006(1)
C(12)	0.045(2)	0.048(2)	0.056(2)	0.006(2)	0.015(2)	0.015(2)
C(13)	0.049(2)	0.067(3)	0.085(3)	-0.001(2)	0.020(2)	0.027(2)
C(14)	0.065(3)	0.057(3)	0.081(3)	-0.021(2)	0.002(2)	0.016(2)
C(15)	0.096(4)	0.043(2)	0.062(3)	-0.010(2)	0.009(2)	-0.005(2)
C(16)	0.065(3)	0.049(2)	0.052(2)	0.002(2)	0.019(2)	-0.003(2)
C(21)	0.048(2)	0.035(2)	0.033(2)	0.008(1)	0.009(1)	0.004(1)
C(22)	0.052(2)	0.056(2)	0.041(2)	0.010(2)	0.006(2)	0.006(2)
C(23)	0.077(3)	0.062(2)	0.049(2)	0.019(2)	-0.006(2)	0.011(2)
C(24)	0.108(4)	0.075(3)	0.037(2)	0.022(3)	0.018(2)	0.009(2)
C(25)	0.102(4)	0.097(3)	0.047(2)	0.035(3)	0.036(2)	0.018(2)
C(26)	0.070(3)	0.077(3)	0.039(2)	0.029(2)	0.022(2)	0.012(2)
C(31)	0.035(2)	0.035(2)	0.032(2)	0.007(1)	0.011(1)	0.004(1)

Table 24 Non – hydrogen thermal parameters of [CuBr(PPh₃)₂(ptu)](cont.).

Atom	U11	U22	U33	U12	U13	U23
C(32)	0.039(2)	0.038(2)	0.073(2)	0.010(2)	0.015(2)	0.013(2)
C(33)	0.041(2)	0.059(2)	0.081(3)	0.010(2)	0.017(2)	0.011(2)
C(34)	0.041(2)	0.070(3)	0.061(2)	0.023(2)	0.008(2)	0.003(2)
C(35)	0.065(3)	0.055(2)	0.076(3)	0.028(2)	0.011(2)	0.018(2)
C(36)	0.046(2)	0.041(2)	0.058(2)	0.008(2)	0.013(2)	0.015(2)
C(41)	0.037(2)	0.034(2)	0.038(2)	0.012(1)	0.016(1)	0.012(1)
C(42)	0.048(2)	0.052(2)	0.045(2)	0.022(2)	0.013(2)	0.005(2)
C(43)	0.061(2)	0.062(2)	0.059(2)	0.037(2)	0.024(2)	0.016(2)
C(44)	0.084(3)	0.044(2)	0.060(2)	0.032(2)	0.031(2)	0.013(2)
C(45)	0.064(2)	0.039(2)	0.053(2)	0.010(2)	0.015(2)	0.001(2)
C(46)	0.041(2)	0.042(2)	0.051(2)	0.014(2)	0.014(2)	0.006(2)
C(51)	0.031(2)	0.029(2)	0.047(2)	0.006(1)	0.012(1)	-0.001(1)
C(52)	0.038(2)	0.049(2)	0.066(2)	0.008(2)	0.010(2)	0.020(2)
C(53)	0.041(2)	0.052(2)	0.082(3)	0.011(2)	-0.005(2)	0.013(2)
C(54)	0.033(2)	0.061(2)	0.099(4)	0.016(2)	0.001(2)	-0.016(2)
C(55)	0.035(2)	0.079(3)	0.083(3)	-0.001(2)	0.025(2)	-0.016(2)
C(56)	0.044(2)	0.064(2)	0.052(2)	0.005(2)	0.021(2)	-0.003(2)
C(61)	0.046(2)	0.036(2)	0.043(2)	0.015(1)	0.019(1)	0.015(1)
C(62)	0.119(4)	0.047(2)	0.059(3)	0.012(2)	0.038(2)	0.014(2)
C(63)	0.153(5)	0.060(3)	0.081(4)	0.027(3)	0.057(3)	0.038(3)
C(64)	0.121(4)	0.097(4)	0.054(3)	0.031(3)	0.025(3)	0.037(3)
C(65)	0.153(5)	0.080(3)	0.044(3)	-0.007(3)	-0.002(3)	0.012(2)
C(66)	0.101(3)	0.047(2)	0.048(2)	-0.000(2)	0.005(2)	0.012(2)

Table 25 Non – hydrogen atom coordinates and isotropic thermal parameters of
 [CuI(PPh₃)₂(ptu)].

Atom	x/a	y/b	z/c	U(eq) A**2
Cu(1A)	0.22484 (6)	0.77723 (4)	0.37656 (3)	0.02320 (17)
Cu(1B)	0.80632 (6)	0.24103 (4)	0.10985 (3)	0.02128 (16)
I(1A)	0.46394 (3)	0.75683 (2)	0.39996 (2)	0.02967 (11)
I(1B)	0.56365 (3)	0.26189 (2)	0.09357 (2)	0.02911 (11)
S(1A)	0.15450 (14)	0.90317 (8)	0.28957 (8)	0.0300 (4)
S(1B)	0.86425 (13)	0.12053 (8)	0.20281 (7)	0.0228 (3)
N(1A)	0.1515 (4)	1.0517 (3)	0.2712 (2)	0.0332 (12)
N(2A)	0.3254 (4)	0.9573 (3)	0.3173 (2)	0.0316 (12)
N(1B)	0.8570 (4)	-0.0299 (2)	0.2387 (2)	0.0316 (12)
N(2B)	0.7271 (4)	0.0587 (2)	0.1580 (2)	0.0267 (11)
P(1A)	0.21516 (14)	0.68413 (8)	0.33399 (7)	0.0217 (3)
P(2A)	0.11408 (14)	0.77457 (8)	0.48212 (7)	0.0229 (3)
P(1B)	0.80062 (13)	0.33467 (8)	0.15518 (7)	0.0212 (3)
P(2B)	0.93858 (14)	0.23217 (8)	0.01210 (7)	0.0214 (3)
C(1A)	0.2138 (5)	0.9760 (3)	0.2929 (3)	0.0246 (13)
C(2A)	0.3955 (5)	1.0065 (3)	0.3258 (3)	0.0297 (14)
C(3A)	0.4523 (5)	0.9764 (3)	0.3850 (3)	0.0332 (15)
C(4A)	0.5344 (5)	1.0157 (3)	0.3924 (3)	0.0376 (16)
C(5A)	0.5582 (6)	1.0846 (3)	0.3425 (3)	0.0375 (16)
C(6A)	0.4991 (6)	1.1147 (3)	0.2848 (3)	0.0366 (16)
C(7A)	0.4180 (5)	1.0764 (3)	0.2742 (3)	0.0326 (15)
C(8A)	0.3242 (5)	0.6753 (3)	0.2570 (3)	0.0247 (13)
C(9A)	0.4422 (6)	0.6943 (4)	0.2459 (3)	0.0379 (16)
C(10A)	0.5348 (6)	0.6796 (4)	0.1941 (3)	0.0454 (18)
C(11A)	0.5100 (6)	0.6469 (3)	0.1513 (3)	0.0417 (17)
C(12A)	0.3918 (6)	0.6299 (3)	0.1613 (3)	0.0363 (15)

Table 25 Non – hydrogen atom coordinates and isotropic thermal parameters of
 [CuI(PPh₃)₂(ptu)] (cont.).

Atom	x/a	y/b	z/c	U(eq) A**2
C(13A)	0.2983 (5)	0.6438 (3)	0.2136 (3)	0.0284 (14)
C(14A)	0.0541 (5)	0.7024 (3)	0.3118 (3)	0.0222 (13)
C(15A)	0.0182 (5)	0.7605 (3)	0.2507 (3)	0.0262 (13)
C(16A)	-0.1063 (5)	0.7808 (3)	0.2361 (3)	0.0268 (13)
C(17A)	-0.1984 (5)	0.7431 (3)	0.2824 (3)	0.0317 (15)
C(18A)	-0.1649 (5)	0.6852 (3)	0.3436 (3)	0.0301 (14)
C(19A)	-0.0399 (5)	0.6652 (3)	0.3582 (3)	0.0239 (13)
C(20A)	0.2465 (5)	0.5804 (3)	0.3896 (3)	0.0234 (13)
C(21A)	0.2035 (5)	0.5231 (3)	0.3786 (3)	0.0267 (13)
C(22A)	0.2318 (5)	0.4449 (3)	0.4208 (3)	0.0314 (14)
C(23A)	0.3049 (6)	0.4212 (3)	0.4727 (3)	0.0387 (16)
C(24A)	0.3487 (6)	0.4768 (3)	0.4842 (3)	0.0395 (16)
C(25A)	0.3192 (5)	0.5558 (3)	0.4431 (3)	0.0309 (14)
C(26A)	-0.0620 (5)	0.7959 (3)	0.4911 (3)	0.0250 (13)
C(27A)	-0.1209 (5)	0.8044 (3)	0.4374 (3)	0.0298 (14)
C(28A)	-0.2544 (6)	0.8164 (4)	0.4434 (3)	0.0406 (16)
C(29A)	-0.3271 (6)	0.8183 (3)	0.5047 (3)	0.0399 (16)
C(30A)	-0.2687 (6)	0.8102 (3)	0.5582 (3)	0.0383 (16)
C(31A)	-0.1364 (5)	0.7979 (3)	0.5520 (3)	0.0333 (15)
C(32A)	0.1544 (5)	0.6755 (3)	0.5464 (3)	0.0253 (13)
C(33A)	0.0754 (6)	0.6219 (3)	0.5641 (3)	0.0368 (16)
C(34A)	0.1128 (7)	0.5448 (4)	0.6079 (3)	0.0501 (19)
C(35A)	0.2258 (7)	0.5201 (4)	0.6355 (3)	0.0477 (18)
C(36A)	0.3056 (7)	0.5711 (4)	0.6186 (3)	0.0454 (17)
C(37A)	0.2700 (6)	0.6486 (3)	0.5740 (3)	0.0333 (15)
C(38A)	0.1383 (5)	0.8424 (3)	0.5191 (3)	0.0277 (14)

Table 25 Non – hydrogen atom coordinates and isotropic thermal parameters of
 [CuI(PPh₃)₂(ptu)] (cont.).

Atom	x/a	y/b	z/c	U(eq) A**2
C(39A)	0.1311 (6)	0.8262 (4)	0.5887 (3)	0.0401 (16)
C(40A)	0.1373 (7)	0.8861 (4)	0.6111 (4)	0.055 (2)
C(41A)	0.1542 (6)	0.9597 (4)	0.5653 (4)	0.054 (2)
C(42A)	0.1626 (7)	0.9743 (4)	0.4973 (4)	0.056 (2)
C(43A)	0.1534 (6)	0.9167 (4)	0.4743 (3)	0.0407 (17)
C(1B)	0.8119 (5)	0.0442 (3)	0.1994 (3)	0.0208 (12)
C(2B)	0.6767 (5)	0.0025 (3)	0.1467 (3)	0.0239 (13)
C(3B)	0.6858 (5)	0.0049 (3)	0.0809 (3)	0.0305 (14)
C(4B)	0.6331 (6)	-0.0459 (4)	0.0672 (3)	0.0382 (16)
C(5B)	0.5700 (6)	-0.0984 (4)	0.1198 (3)	0.0386 (16)
C(6B)	0.5607 (5)	-0.1007 (3)	0.1860 (3)	0.0388 (16)
C(7B)	0.6145 (5)	-0.0498 (3)	0.2000 (3)	0.0263 (13)
C(8B)	0.6712 (5)	0.3423 (3)	0.2242 (3)	0.0246 (13)
C(9B)	0.6550 (6)	0.2738 (3)	0.2773 (3)	0.0447 (18)
C(10B)	0.4746 (6)	0.3436 (4)	0.3325 (4)	0.0490 (19)
C(11B)	0.4896 (6)	0.4126 (4)	0.2810 (4)	0.056 (2)
C(12B)	0.5880 (6)	0.4124 (4)	0.2276 (3)	0.0464 (18)
C(13B)	0.9462 (5)	0.3192 (3)	0.1916 (3)	0.0199 (12)
C(14B)	1.0621 (5)	0.2804 (3)	0.1645 (3)	0.0268 (13)
C(15B)	1.1759 (6)	0.2696 (3)	0.1883 (3)	0.0349 (15)
C(16B)	1.1761 (6)	0.2939 (3)	0.2413 (3)	0.0340 (15)
C(17B)	1.0622 (6)	0.3306 (3)	0.2698 (3)	0.0326 (15)
C(18B)	0.9478 (6)	0.3446 (3)	0.2453 (3)	0.0271 (13)
C(19B)	0.7774 (5)	0.4363 (3)	0.0956 (3)	0.0225 (13)
C(20B)	0.8678 (5)	0.4821 (3)	0.0775 (3)	0.0284 (14)
C(21B)	0.8473 (6)	0.5571 (3)	0.0279 (3)	0.0356 (15)

Table 25 Non – hydrogen atom coordinates and isotropic thermal parameters of
 [CuI(PPh₃)₂(ptu)] (cont.).

Atom	x/a	y/b	z/c	U(eq) A**2
C(22B)	0.7355 (6)	0.5873 (3)	−0.0025 (3)	0.0353 (15)
C(23B)	0.6440 (6)	0.5429 (3)	0.0158 (3)	0.0328 (15)
C(24B)	0.6657 (6)	0.4678 (3)	0.0640 (3)	0.0289 (14)
C(25B)	1.1067 (5)	0.1898 (3)	0.0278 (3)	0.0204 (12)
C(26B)	1.2036 (5)	0.2323 (3)	−0.0020 (3)	0.0297 (14)
C(27B)	1.3245 (6)	0.2011 (4)	0.0189 (3)	0.0370 (16)
C(28B)	1.3524 (6)	0.1279 (4)	0.0696 (3)	0.0351 (15)
C(29B)	1.2581 (5)	0.0846 (3)	0.0989 (3)	0.0307 (14)
C(30B)	1.1364 (5)	0.1156 (3)	0.0781 (3)	0.0273 (13)
C(31B)	0.9415 (5)	0.3227 (3)	−0.0624 (3)	0.0242 (13)
C(32B)	0.8565 (6)	0.3940 (3)	−0.0611 (3)	0.0316 (14)
C(33B)	0.8536 (7)	0.4618 (4)	−0.1195 (3)	0.0461 (18)
C(34B)	0.9325 (7)	0.4593 (4)	−0.1779 (3)	0.0484 (19)
C(35B)	1.0163 (7)	0.3897 (4)	−0.1803 (3)	0.0461 (18)
C(36B)	1.0202 (6)	0.3215 (3)	−0.1234 (3)	0.0366 (15)
C(37B)	0.9045 (5)	0.1720 (3)	−0.0295 (3)	0.0194 (12)
C(38B)	0.9928 (5)	0.1096 (3)	−0.0451 (3)	0.0236 (13)
C(39B)	0.9595 (6)	0.0719 (3)	−0.0819 (3)	0.0313 (14)
C(40B)	0.8404 (6)	0.0960 (3)	−0.1029 (3)	0.0312 (15)
C(41B)	0.7513 (6)	0.1577 (3)	−0.0879 (3)	0.0305 (14)
C(42B)	0.7827 (5)	0.1956 (3)	−0.0506 (3)	0.0287 (14)
C(43B)	0.5600 (7)	0.2748 (4)	0.3319 (3)	0.053 (2)

Table 26 Non – hydrogen thermal parameters of [CuI(PPh₃)₂(ptu)].

Atom	U11	U22	U33	U12	U13	U23
Cu(1A)	0.0238 (4)	0.0223 (4)	0.0256 (4)	−0.0074 (3)	−0.0024 (3)	−0.0092 (3)
Cu(1B)	0.0239 (4)	0.0165 (3)	0.0254 (4)	−0.0047 (3)	−0.0050 (3)	−0.0082 (3)
I(1A)	0.0237 (2)	0.0261 (2)	0.0380 (3)	−0.0061 (18)	−0.00825 (18)	−0.0069 (19)
I(1B)	0.0247 (2)	0.0208 (2)	0.0409 (3)	−0.0042 (17)	−0.01189 (18)	−0.0059 (18)
S(1A)	0.0375 (9)	0.0223 (8)	0.0324 (9)	−0.0072 (7)	−0.0164 (7)	−0.0048 (7)
S(1B)	0.0289 (8)	0.0168 (7)	0.0249 (8)	−0.0047 (6)	−0.0088 (6)	−0.0070 (6)
N(1A)	0.035 (3)	0.025 (3)	0.044 (3)	−0.006 (2)	−0.017 (2)	−0.010 (2)
N(2A)	0.035 (3)	0.020 (3)	0.044 (3)	−0.010 (2)	−0.012 (3)	−0.008 (2)
N(1B)	0.044 (3)	0.014 (2)	0.040 (3)	−0.005 (2)	−0.021 (3)	−0.004 (2)
N(2B)	0.030 (3)	0.014 (2)	0.036 (3)	−0.001 (2)	−0.017 (2)	−0.005 (2)
P(1A)	0.0254 (8)	0.0174 (7)	0.0224 (8)	−0.0066 (7)	−0.0023 (7)	−0.0061 (6)
P(2A)	0.0250 (8)	0.0230 (8)	0.0232 (8)	−0.0082 (7)	−0.0017 (7)	−0.0095 (7)
P(1B)	0.0237(8)	0.0158 (7)	0.0251 (8)	−0.0041 (6)	−0.0041 (7)	−0.0078 (6)
P(2B)	0.0250(8)	0.0178 (8)	0.0236 (8)	−0.0061 (6)	−0.0043 (7)	−0.0077 (7)
C(1A)	0.034 (4)	0.019 (3)	0.019 (3)	−0.003 (3)	−0.005 (3)	−0.005 (3)
C(2A)	0.028 (3)	0.028 (3)	0.034 (4)	−0.004 (3)	−0.005 (3)	−0.012 (3)
C(3A)	0.037 (4)	0.028 (3)	0.036 (4)	−0.014 (3)	−0.009 (3)	−0.005 (3)
C(4A)	0.031 (4)	0.035 (4)	0.050 (4)	−0.011 (3)	−0.008 (3)	−0.015 (3)
C(5A)	0.040 (4)	0.028 (4)	0.051 (4)	−0.016 (3)	−0.006 (3)	−0.015 (3)
C(6A)	0.038 (4)	0.023 (3)	0.045 (4)	−0.013 (3)	0.004 (3)	−0.009 (3)
C(7A)	0.033 (4)	0.028 (3)	0.033 (4)	−0.009 (3)	−0.003 (3)	−0.005 (3)
C(8A)	0.027 (3)	0.016 (3)	0.028 (3)	−0.006 (3)	0.002 (3)	−0.004 (3)
C(9A)	0.042 (4)	0.045 (4)	0.030 (4)	−0.019 (3)	0.009 (3)	−0.018 (3)
C(10A)	0.037 (4)	0.061 (5)	0.047 (4)	−0.024 (4)	0.013 (3)	−0.030 (4)
C(11A)	0.057 (5)	0.029 (4)	0.032 (4)	−0.006 (3)	0.012 (3)	−0.013 (3)
C(12A)	0.052 (4)	0.025 (3)	0.032 (4)	−0.005 (3)	−0.004 (3)	−0.014 (3)
C(13A)	0.030 (3)	0.023 (3)	0.032 (4)	−0.006 (3)	0.000 (3)	−0.011 (3)

Table 26 Non – hydrogen thermal parameters of [CuI(PPh₃)₂(ptu)] (cont.).

Atom	U11	U22	U33	U12	U13	U23
C(14A)	0.025 (3)	0.020 (3)	0.026 (3)	-0.002 (3)	0.000 (3)	-0.016 (3)
C(15A)	0.033 (3)	0.023 (3)	0.027 (3)	-0.011 (3)	-0.001 (3)	-0.011 (3)
C(16A)	0.031 (3)	0.022 (3)	0.027 (3)	-0.002 (3)	-0.009 (3)	-0.009 (3)
C(17A)	0.023 (3)	0.036 (4)	0.045 (4)	-0.001 (3)	-0.012 (3)	-0.023 (3)
C(18A)	0.030 (3)	0.030 (3)	0.033 (4)	-0.014 (3)	0.003 (3)	-0.012 (3)
C(19A)	0.037 (4)	0.013 (3)	0.019 (3)	-0.004 (3)	-0.003 (3)	-0.003 (2)
C(20A)	0.020 (3)	0.017 (3)	0.027 (3)	-0.002 (2)	0.003 (3)	-0.006 (3)
C(21A)	0.024 (3)	0.019 (3)	0.033 (4)	-0.003 (3)	-0.001 (3)	-0.009 (3)
C(22A)	0.028 (3)	0.021 (3)	0.043 (4)	-0.010 (3)	0.005 (3)	-0.011 (3)
C(23A)	0.043 (4)	0.016 (3)	0.044 (4)	-0.003 (3)	0.007 (3)	-0.006 (3)
C(24A)	0.048 (4)	0.029 (4)	0.029 (4)	0.004 (3)	-0.010 (3)	-0.002 (3)
C(25A)	0.037 (4)	0.026 (3)	0.028 (3)	-0.001 (3)	-0.003 (3)	-0.011 (3)
C(26A)	0.021 (3)	0.022 (3)	0.035 (4)	-0.006 (3)	-0.004 (3)	-0.012 (3)
C(27A)	0.026 (3)	0.033 (3)	0.036 (4)	-0.007 (3)	0.002 (3)	-0.019 (3)
C(28A)	0.039 (4)	0.045 (4)	0.044 (4)	-0.006 (3)	-0.019 (3)	-0.016 (3)
C(29A)	0.025 (4)	0.037 (4)	0.052 (5)	-0.008 (3)	-0.001 (3)	-0.012 (3)
C(30A)	0.036 (4)	0.041 (4)	0.030 (4)	-0.007 (3)	0.001 (3)	-0.008 (3)
C(31A)	0.030 (4)	0.044 (4)	0.029 (4)	-0.008 (3)	-0.008 (3)	-0.014 (3)
C(32A)	0.026 (3)	0.021 (3)	0.027 (3)	-0.005 (3)	0.005 (3)	-0.011 (3)
C(33A)	0.034 (4)	0.026 (3)	0.049 (4)	-0.004 (3)	0.000 (3)	-0.016 (3)
C(34A)	0.059 (5)	0.027 (4)	0.058 (5)	-0.018 (4)	0.008 (4)	-0.010 (4)
C(35A)	0.057 (5)	0.029 (4)	0.042 (4)	-0.007 (4)	-0.003 (4)	0.001 (3)
C(36A)	0.053 (4)	0.038 (4)	0.039 (4)	-0.005 (4)	-0.016 (3)	-0.004 (3)
C(37A)	0.036 (4)	0.037 (4)	0.031 (4)	-0.008 (3)	-0.007 (3)	-0.014 (3)
C(38A)	0.027 (3)	0.030 (3)	0.030 (4)	-0.009 (3)	0.001 (3)	-0.014 (3)
C(39A)	0.054 (4)	0.037 (4)	0.033 (4)	-0.008 (3)	-0.014 (3)	-0.012 (3)
C(40A)	0.066 (5)	0.065 (5)	0.051 (5)	-0.007 (4)	-0.024 (4)	-0.035 (4)

Table 26 Non – hydrogen thermal parameters of [CuI(PPh₃)₂(ptu)] (cont.).

Atom	U11	U22	U33	U12	U13	U23
C(41A)	0.044 (4)	0.063 (5)	0.086 (6)	-0.008 (4)	-0.012 (4)	-0.060 (5)
C(42A)	0.070 (5)	0.046 (5)	0.071 (6)	-0.027 (4)	0.007 (4)	-0.038 (4)
C(43A)	0.055 (4)	0.038 (4)	0.037 (4)	-0.021 (3)	0.009 (3)	-0.022 (3)
C(1B)	0.018 (3)	0.017 (3)	0.023 (3)	-0.003 (2)	-0.002 (2)	-0.004 (3)
C(2B)	0.026 (3)	0.017 (3)	0.029 (3)	-0.006 (3)	-0.006 (3)	-0.006 (3)
C(3B)	0.031 (3)	0.029 (3)	0.029 (4)	-0.006 (3)	-0.003 (3)	-0.009 (3)
C(4B)	0.040 (4)	0.045 (4)	0.044 (4)	-0.010 (3)	-0.006 (3)	-0.030 (3)
C(5B)	0.034 (4)	0.038 (4)	0.058 (5)	-0.013 (3)	-0.011 (3)	-0.025 (4)
C(6B)	0.029 (4)	0.029 (4)	0.057 (5)	-0.015 (3)	-0.001 (3)	-0.010 (3)
C(7B)	0.027 (3)	0.026 (3)	0.024 (3)	-0.006 (3)	-0.003 (3)	-0.008 (3)
C(8B)	0.031 (3)	0.018 (3)	0.028 (3)	-0.007 (3)	-0.006 (3)	-0.010 (3)
C(9B)	0.052 (4)	0.023 (4)	0.051 (4)	-0.005 (3)	0.016 (4)	-0.019 (3)
C(10B)	0.041 (4)	0.046 (5)	0.057 (5)	-0.010 (4)	0.018 (4)	-0.029 (4)
C(11B)	0.050 (5)	0.041 (4)	0.057 (5)	0.015 (4)	0.009 (4)	-0.023 (4)
C(12B)	0.058 (5)	0.025 (4)	0.035 (4)	0.008 (3)	0.000 (3)	-0.003 (3)
C(13B)	0.027 (3)	0.013 (3)	0.019 (3)	-0.006 (2)	-0.004 (2)	-0.003 (2)
C(14B)	0.032 (3)	0.018 (3)	0.031 (3)	-0.004 (3)	-0.003 (3)	-0.012 (3)
C(15B)	0.024 (3)	0.039 (4)	0.039 (4)	-0.003 (3)	-0.005 (3)	-0.012 (3)
C5(16B)	0.040 (4)	0.026 (3)	0.035 (4)	-0.009 (3)	-0.020 (3)	-0.001 (3)
C(17B)	0.047 (4)	0.025 (3)	0.025 (3)	-0.008 (3)	-0.012 (3)	-0.004 (3)
C(18B)	0.038 (4)	0.023 (3)	0.021 (3)	-0.010 (3)	-0.002 (3)	-0.005 (3)
C(19B)	0.032 (3)	0.018 (3)	0.023 (3)	-0.006 (3)	-0.006 (3)	-0.010 (3)
C(20B)	0.033 (3)	0.026 (3)	0.027 (3)	-0.007 (3)	-0.008 (3)	-0.007 (3)
C(21B)	0.033 (4)	0.024 (3)	0.048 (4)	-0.012 (3)	0.001 (3)	-0.009 (3)
C(22B)	0.047 (4)	0.017 (3)	0.034 (4)	-0.002 (3)	-0.004 (3)	-0.005 (3)
C(23B)	0.034 (4)	0.023 (3)	0.039 (4)	0.001 (3)	-0.017 (3)	-0.007 (3)
C(24B)	0.041 (4)	0.019 (3)	0.032 (4)	-0.010 (3)	-0.009 (3)	-0.009 (3)

Table 26 Non – hydrogen thermal parameters of [CuI(PPh₃)₂(ptu)] (cont.).

Atom	U11	U22	U33	U12	U13	U23
C(25B)	0.023 (3)	0.024 (3)	0.020 (3)	−0.008 (3)	−0.002 (2)	−0.013 (3)
C(26B)	0.039 (4)	0.027 (3)	0.032 (4)	−0.012 (3)	−0.004 (3)	−0.015 (3)
C(27B)	0.034 (4)	0.033 (4)	0.054 (4)	−0.015 (3)	−0.006 (3)	−0.019 (3)
C(28B)	0.027 (3)	0.044 (4)	0.045 (4)	0.003 (3)	−0.014 (3)	−0.029 (3)
C(29B)	0.033 (4)	0.029 (3)	0.030 (4)	0.006 (3)	−0.010 (3)	−0.015 (3)
C(30B)	0.035 (4)	0.030 (3)	0.024 (3)	−0.011 (3)	−0.002 (3)	−0.015 (3)
C(31B)	0.033 (3)	0.022 (3)	0.020 (3)	−0.009 (3)	−0.007 (3)	−0.006 (3)
C(32B)	0.043 (4)	0.023 (3)	0.030 (4)	0.000 (3)	−0.010 (3)	−0.013 (3)
C(33B)	0.073 (5)	0.022 (4)	0.041 (4)	−0.006 (3)	−0.012 (4)	−0.009 (3)
C(34B)	0.083 (6)	0.025 (4)	0.039 (4)	−0.027 (4)	−0.014 (4)	0.002 (3)
C(35B)	0.072 (5)	0.040 (4)	0.027 (4)	−0.028 (4)	0.004 (3)	−0.007 (3)
C(36B)	0.054 (4)	0.026 (3)	0.030 (4)	−0.009 (3)	−0.010 (3)	−0.008 (3)
C(37B)	0.023 (3)	0.016 (3)	0.016 (3)	−0.006 (2)	−0.003 (2)	−0.001 (2)
C(38B)	0.032 (3)	0.017 (3)	0.025 (3)	−0.011 (3)	−0.006 (3)	−0.005 (3)
C(39B)	0.048 (4)	0.020 (3)	0.028 (3)	−0.011 (3)	0.000 (3)	−0.009 (3)
C(40B)	0.059 (4)	0.018 (3)	0.025 (3)	−0.019 (3)	−0.010 (3)	−0.005 (3)
C(41B)	0.039 (4)	0.030 (3)	0.026 (3)	−0.018 (3)	−0.015 (3)	0.000 (3)
C(42B)	0.041 (4)	0.019 (3)	0.025 (3)	−0.011 (3)	−0.004 (3)	−0.004 (3)
C(43B)	0.070 (5)	0.033 (4)	0.049 (5)	−0.023 (4)	0.028 (4)	−0.017 (4)

VITAE

Name Miss Ruthairat Nimtong

Student ID 4822063

Educational Attainment

Degree	Name of Institution	Year of Graduation
Bachelor of Science (Chemistry)	Prince of Songkla University	2004

Scholarship Awards during Enrolment

Higher Education Development Project: Center for Innovation in Chemistry :
Postgraduate Education and Research Program in Chemistry (PERCH-CIC).

List of Publication and Proceeding

Presentations

Oral presentation

1. Ruthairat Nimthong, Chaveng Pakawatchai, Yupa Thunyasirikul and Saowanit Saithong: Structural and Spectroscopic Studies of Triphenylphosphine and Phenylthiourea Copper(I) Complexes, 5th PERCH-CIC Annual Scientific Congress (PERCH-CIC Congress V), Pattaya, Thailand, May 6-9, 2007.

Poster presentations

1. Ruthairat Nimthong, Chaveng Pakawatchai, Yupa Thunyasirikul and Saowanit Saithong: Mixed Ligand Copper(I) Complexes of Triphenylphosphine and Phenylthiourea, 8th Conference of the Asian Crystallographic Association, Taipei, Taiwan, November, 4-7, 2007.
2. Ruthairat Nimthong, Chaveng Pakawatchai, Yupa Thunyasirikul and Saowanit Saithong: Copper(I) iodide Complex with Triphenylphosphine and Phenylthiourea, The 32nd Congress on Science and Technology of Thailand (STT.32), Bangkok, Thailand, October 10-12, 2006.